

Ualpin



VOGLAUER

Valpin

Aus Freude am Original

The pleasure of going back to basics

Le plaisir du retour aux sources

Wir achten bewusst darauf, die im Holz **charakteristischen Lebenslinien**, aber auch die **Inschrift und Spuren** zu erhalten. Es sind Möbel, die **Individualität und Wärme** vermitteln und zugleich in außergewöhnlicher Weise den Spagat zwischen Tradition und Moderne schaffen.

We make sure that the **wood's characteristic life lines** as well as **inscriptions and marks** are retained. These are **unique and warm pieces of furniture** that combine tradition and modernity.

Nous nous efforçons de préserver les **lignes de vie caractéristiques** du bois ainsi que les différentes **marques**. Ce sont des **meubles singuliers et chaleureux** qui réussissent à concilier tradition et modernité.



Valpin Video



100% NATUR
nature | nature

100% DESIGN
design | design

100% DURCHDACHT
sophisticated | bien pensé

100% VERANTWORTUNG
responsibility | responsabilité



Design. Natur. Handwerk.

Design. Nature. Craftsmanship.

Le design. La nature. L'artisanat.



Naturholzmöbel aus nachhaltigem Anbau

Natural wood furniture made from sustainable timber

Meubles en bois naturel issu de plantations durables



Bekenntnis zu Natur und Qualität seit über 90 Jahren

Commitment to nature and quality for more than 90 years

L'engagement de produire des meubles naturels de qualité depuis plus de 90 ans



Naturholzmöbel sorgen für ein gesundes Raumklima

Natural wood furniture ensure a healthy room climate

Les meubles en bois naturel assurent un climat ambiant particulièrement sain



Innovativ mit Rücksicht auf die grüne und soziale Umwelt

Innovative in caring for the social and natural environment

Innover en prenant soin de l'environnement social et naturel



Zertifiziert und ausgezeichnet

Certified and award-winning

Certifié et récompensé



AV154 | Eiche Altholz | Colorglas anthrazit
Reclaimed oak wood | Chêne ancien



Inspirierend, echt & unverfälscht

Inspirational, real & genuine

Source d'inspiration, réel et authentique



Am Puls der Zeit – offen – flexibel – intelligent

State of the art – open – flexible – intelligent

Dans l'air du temps – ouvert – flexible – intelligent

AV298 | Eiche Altholz | Colorglas anthrazit
Reclaimed oak wood | Glass anthracite
Chêne ancien | Verre anthracite

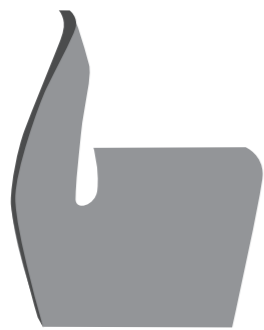

Variante 1



Variante 2

Von den Alpen inspiriert

Inspired by the Alps

Inspiré des Alpes





Die Tischeinlage in Steinoptik ist aus Steinzeug, welches auch als Keramikplatte bezeichnet wird. Keramik deshalb, um durch Hitze von Kochtopf und Abrieb von Geschirr, bestmögliche Widerstandsfähigkeit zu erreichen.

The stone-look table insert is made of stoneware, which is also known as a ceramic plate. Ceramic is used to achieve the best possible resistance to heat from cooking pots and abrasion from dishes.

Le centre de table à l'aspect pierre est en grès, également appelé plaque céramique. La céramique résiste à la chaleur des casseroles et à l'abrasion de la vaisselle, pour obtenir la meilleure résistance possible.





Esszimmer Interior, das begeistert und Emotionen weckt

A dining room interior that inspires and awakens the emotions

Une salle à manger qui ravit et éveille les émotions





SAGP76
B 60 cm
T 58 cm
H 82 cm



SAGP78
B 60 cm
T 59 cm
H 82 cm



SAGP77
B 58 cm
T 62 cm
H 82 cm



SEHP35
B 54 cm
T 57 cm
H 82 cm
stapelbar



SEGP35
B 53 cm
T 57 cm
H 82 cm
stapelbar



SAGP37
B 57 cm
T 58 cm
H 83 cm



SEGP36
B 57 cm
T 57 cm
H 82 cm



SEHP55
B 54 cm
T 61 cm
H 86 cm
stapelbar



SEGP64
B 50 cm
T 61 cm
H 88 cm



SEGP65
B 50 cm
T 61 cm
H 85 cm



SEGP66
B 50 cm
T 61 cm
H 85 cm



BAH35 und BAN35
B 52 cm
T 51,5 cm
H 103 cm
und
B 51 cm
T 49 cm
H 93 cm

Urbanität trifft Natur

Urbanity meets nature

L'urbanité rencontre la nature



AVI28 | Eiche Altholz | Colorglas anthrazit
Reclaimed oak wood | Glass anthracite
Chêne ancien | Verre anthracite



AV28 | Eiche Altholz | Colorglas optiwhite
Reclaimed oak wood | Glass optiwhite
Chêne ancien | Verre optiwhite



Tradition modern interpretiert

Tradition with a modern interpretation

La tradition interprétée de façon moderne



AV283 | Eiche Altholz | Colorglas anthrazit
Reclaimed oak wood | Glass anthracite
Chêne ancien | Verre anthracite



Der Vorzug der Zeitlosigkeit

The virtue of timelessness

La vertu de l'intemporalité



100% DESIGN

100% design

Eiche Altholz ist pure Freude am natürlichen Material

Reclaimed oak wood offers the pure joy of natural materials

Le chêne ancien constitue le plaisir pur de la matière naturelle

Die Möbellinie Valpin erinnert an alte „Stadl'n“ und versetzt das Ambiente in einen alpinen Kontext: spannend ist der Kontrast zwischen der puristischen Formensprache und dem besonderen Material. Jede Maserung ist individuell gewachsen, zudem bringt das Altholz durch unterschiedliche Einsatzbereiche seine eigene Geschichte mit.

The Valpin furniture range is reminiscent of old barns and provides an alpine atmosphere: the contrast between the purist design language and the special material is exciting. Each grain is grown individually and thanks to its different areas of use the old wood comes with its own history.

La ligne de meubles Valpin rappelle les anciens greniers et place l'atmosphère dans un contexte alpin : le contraste entre le langage des formes épurées et la matière particulière est saisissant. Chaque veinure s'est développée individuellement. En outre, le bois ancien apporte sa propre histoire au travers des nombreux domaines d'utilisation.



Funktionen, die überzeugen

Convincing functions

Des fonctionnalités convaincantes



1 geschlossen
close
fermer



2 aufklappen
open
ouvrir



3 verschieben
move
faire coulisser

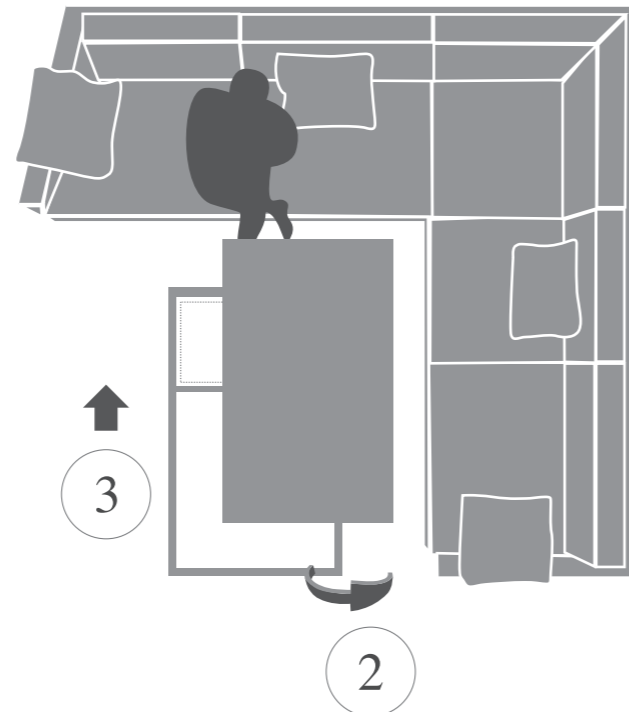
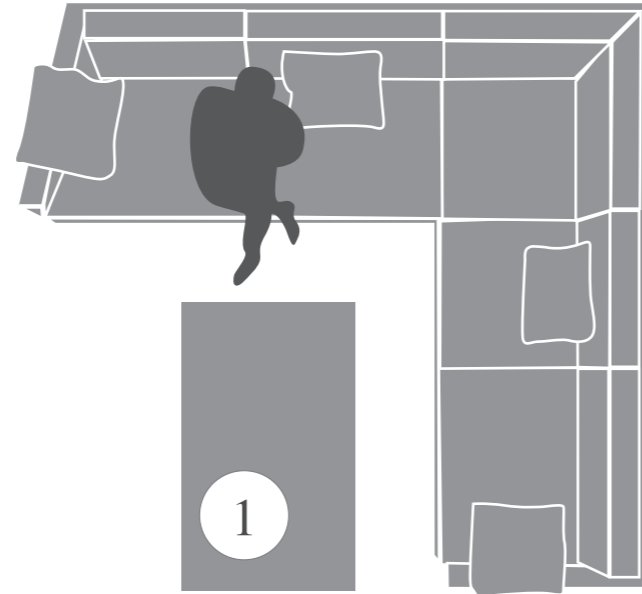

Eiche Altholz | Colorglas optiwhite
Reclaimed oak wood | Glass optiwhite
Chêne ancien | Verre optiwhite



Langer Couchtisch auch mit Tür für Stauraum.

Long Coffee table also with door for storage space.

Table basse avec porte pour rangement.



Couchtisch mit absolutem Mehrwert:
In die Höhe schwenken und drehen für jede Situation.

Coffee table with true added value.
It can be swivelled upwards and rotate for every situations.

Table basse d'une plus-value absolue.
Pivotante et relevable pour chaque situation.

Durch einen einfachen Handgriff lässt sich der Tisch in der Höhe verstellen und eignet sich auch ideal zum Essen.

Just a simple movement alters the height of the table and makes it ideal to eat at.

Grâce à une poignée simple à utiliser, la table est réglable en hauteur. Elle est ainsi idéale pour prendre un repas.





AV175 | Eiche Altholz | Colorglas optiwhite
 Reclaimed oak wood | Glass optiwhite
 Chêne ancien | Verre optiwhite



Wohnflair mit vielen Funktionen

Charming interior with many functions

Intérieur de charme aux nombreuses fonctions





Für jeden Gebrauch das richtige Möbel

The right furniture to meet every need

Le meuble idéal pour chaque utilisation



Office integriert im Wohnzimmer

Office integrated in the living room

Bureau intégré au salon



AV224 | Eiche Altholz | Colorglas anthrazit
Reclaimed oak wood | Glass anthracite
Chêne ancien | Verre anthracite

Mit allen Sinnen wohnen

Living with all your senses

Vivre en harmonie avec vos sens



AV 518 | Eiche Altholz | Glas optiwhite
Reclaimed oak wood | Chêne ancien



Eiche Altholz | Leder schwarz LS
Reclaimed oak wood | Black leather
Chêne ancien | Cuir noir

Massivholz in vollendeter Ausformung

Solid wood in perfect shape

Le bois massif dans sa forme parfaite



Eiche Altholz | Leder schwarz LS
Reclaimed oak wood | Black leather
Chêne ancien | Cuir noir



Mit dem attraktiven Einhand-Beschlag kann der Tisch wahlweise auf jeder Seite um 50 cm verlängert werden. Das Tischgestell bleibt dabei fix auf Standposition.
Tischplatte abgerundet oder gerade.

Each side of the table can be extended up to 50 cm using the single handle. The table frame remains fixed in its standing position.
Tabletop rounded or straight.

Le mécanisme manuel permet de rallonger la table de 50 cm de chaque côté. Le pied de table reste fixe.
Plateau de table arrondi ou droit.



Die puristischen Möbel von Valpin in Eiche Altholz sorgen für außergewöhnliches Wohnflair – sowohl für den urbanen als auch für den ländlichen Lebensraum.

Valpin furniture with pure lines made of old oak wood provides exceptional living flair – both in urban and rural settings.

Les meubles aux lignes épurées Valpin en chêne ancien assurent un charme exceptionnel – aussi bien dans un espace de vie urbain que campagnard.



AV126 | Eiche Altholz | Colorglas optiwhite
Reclaimed oak wood | Glass optiwhite
Chêne ancien | Verre optiwhite

Inspiration für jeden Raum

Inspiration for every room

Une inspiration pour chaque pièce



AV140 | Eiche Altholz | Colorglas anthrazit
Reclaimed oak wood | Glass anthracite
Chêne ancien | Verre anthracite



Holz & Glas – ein spannender Materialmix

Wood & glass – an exciting mix of materials

Bois et verre – une alliance de matériaux fascinante



Dielen



Folder auf unserer Homepage anfordern.
Wir senden Ihnen diese gerne kostenlos zu.



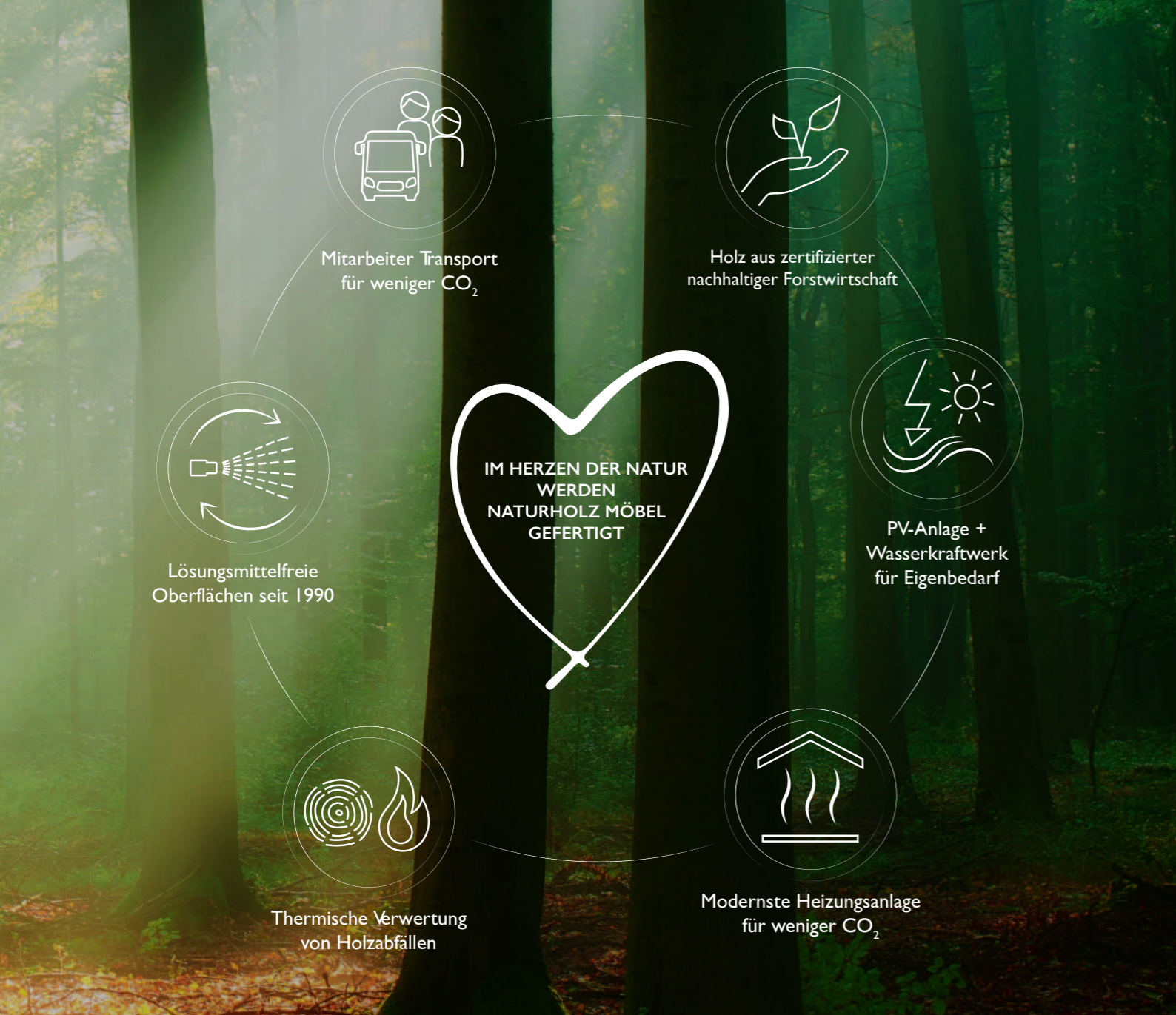

Im Kreislauf mit der Natur

Als verantwortungsvoller Produzent von Naturholzmöbeln steht die Marke Voglauer seit jeher für einen nachhaltigen Umgang mit den Ressourcen der Natur. Daher werden im Fertigungsprozess ausschließlich Hölzer aus nachhaltiger Forstwirtschaft verwendet, womit Voglauer voll im Kreislauf mit der Natur produziert.

Jeder verwendete Baum, den man sich als Möbel ins Haus holt, wächst mit Garantie wieder nach.

Die Möbel von Valpin bestehen nicht nur durch formvollendetes Design, sondern auch durch höchste Qualität und Natürlichkeit.

Damit die natürlichen Oberflächen dieser Möbel besonders gut zum Ausdruck kommen, werden sie mit dem einzigartigen Voglauer Oberflächensortiment behandelt. Aus nachwachsenden Rohstoffen hergestellt, schafft diese Hartöl-Wachskombination auf Basis pflanzlicher Öle die perfekten Voraussetzungen für gesundes Wohnen.

Voglauer Qualitätssiegel

Voglauer seal of quality | La qualité Voglauer

Achten Sie auf das Voglauer Label und den Brennstempel – das Qualitätssiegel für originale Voglauer Möbel aus dem Salzburger Land. Hier kaufen Sie höchste Qualität und Natürlichkeit!

The Voglauer label and the branding iron are the hallmark of quality for original Voglauer furniture from Salzburger Land. Here you will purchase premium quality and naturalness!



Les labels Voglauer sont la marque de qualité de meubles originaux provenant du Salzburger Land. Chez Voglauer, vous ne trouverez que des meubles naturels et de qualité supérieure!

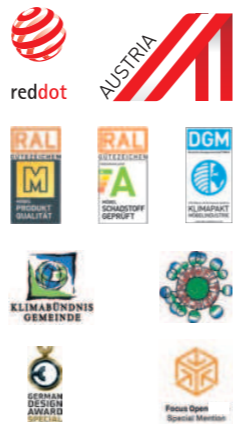

Sorgsam ausgesuchte Hölzer

Carefully selected wood | Des bois sélectionnés avec soin



Eiche Altholz

Akzent Front: Colorglas

Accent front: satin glass | Accent verre satiné

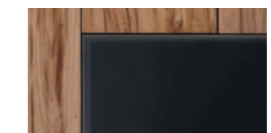

A | anthrazit



O | optiwhite

Bezugstoff Fabric | Tissu d'ameublement

* eingeschränkt verfügbar, siehe Typenliste (Webseite)

Loden Loden | Loden

Loden besteht aus 100 % reiner Merino-Schurwolle und ist daher ein hochwertiges Naturprodukt. Der Rohstoff Wolle ist langlebig, luftdurchlässig, hautfreundlich, elastisch, isolierend und durch seinen Fettgehalt schmutzabweisend.

Loden consists of 100% pure Merino Wool, and is therefore a high-quality natural product. Raw wool is durable, breathable, skin-friendly, elastic, insulating and dirt resistant due to its fat content.

Le loden est composé à 100 % de pure laine vierge mérinos et est de ce fait un produit naturel de grande valeur. La matière première laine présente une durée de vie élevée, est perméable à l'air, agréable sur la peau, élastique, isolante et repousse la saleté grâce à sa teneur en graisse.



MG | grauweiß



MB | basaltgrau



MT | tundrabraun

Leder Leather | Cuir

Kräftiges, weiches Rindleder mit markanter Oberflächenstruktur (Millkorn) und hochwertigen Farbpigmenten.

Strong, soft cowhide leather with distinctive surface structure and high-quality colour pigments.

Cuir de vachette résistant, souple, à la surface remarquable et aux pigments colorés haut de gamme.

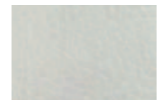

LR | reinweiß



LW | sahne



LY | ziegelrot



LX | burgundy



LZ | army green



LV | cognac



LU | caffè

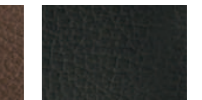

LT | testa di moro



LK | kiesel



LO | coco



LM | stone

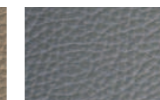

LP | cenere

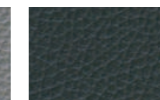

LN | anthrazit

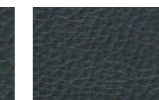

LL | oceano



LS | schwarz



LA | azurblau

Vintage Vintage | Vintage



VQ | quarz



VB | bronze



VT | terra



VM | moor

Textilleider in used look aus 100% Mikrofaser (PES)
Faux leather in used look made from 100% microfiber (PES).
Cuir synthétique effet usé, 100% microfibras (PES).

Curl Curl | Curl (Bezugstoff)



CN | natur



CM | melange



CW | warm grey



CT | timber



CS | steele

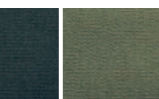

CB | black



CO | olive



CD | dark blue



CR | royal red

Textil in Naturhaptik mit höchster Schmutzabweisende Eigenschaft (Patentierter Q2 Faser, 74/26 PAN/PES)
Textile in natural haptics with highest dirt-repellent property (patented Q2 fiber, 74/26 PAN/PES)
Textile au touché naturel avec propriétés hautement anti-poussière (breveté Q2 fibre, 74/26 PAN/PES)

Select Select | Select



SB | basaltbraun

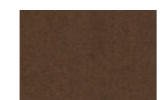

SK | kupfer



SN | natur



SU | umbra

Textil mit natürlicher Haptik aus Mischgewebe (29 % PES, 27 % PAN, 22 % CV, 13 % WO, 9 % CO).
Textile with a natural feel made from blended fabric (29 % PES, 27 % PAN, 22 % CV, 13 % WO, 9 % CO).
Textile au toucher naturel en tissu mélangé (29 % PES, 27 % PAN, 22 % CV, 13 % WO, 9 % CO).



SH | honiggelb



SM | mineralblau



SS | schwarz



Farbbildungen dienen nicht als Farbmuster!

Sideboards

Alle Elemente auch spiegelbildlich lieferbar

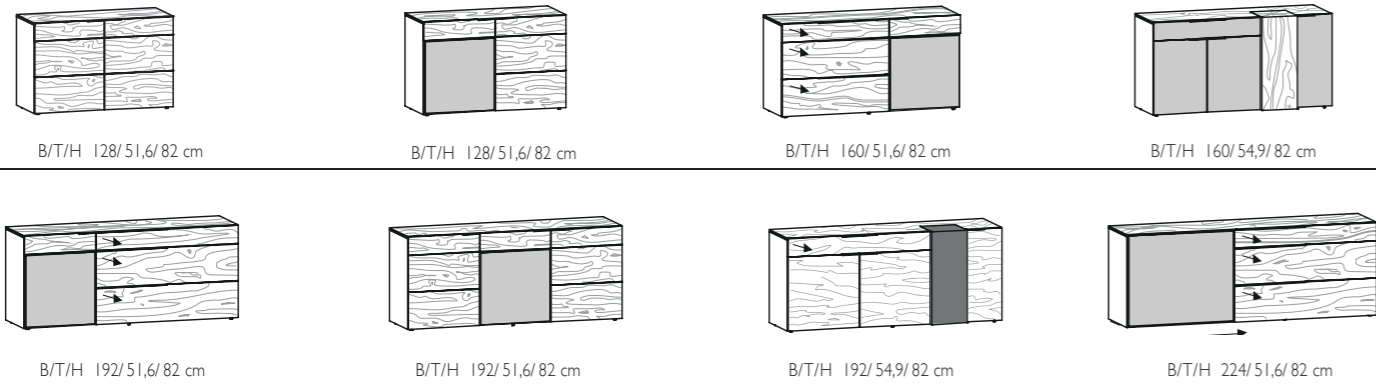

Highboards

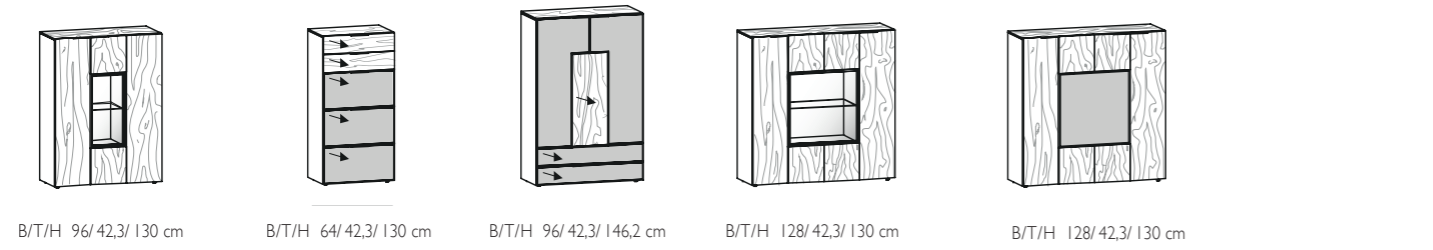

Vitrinen

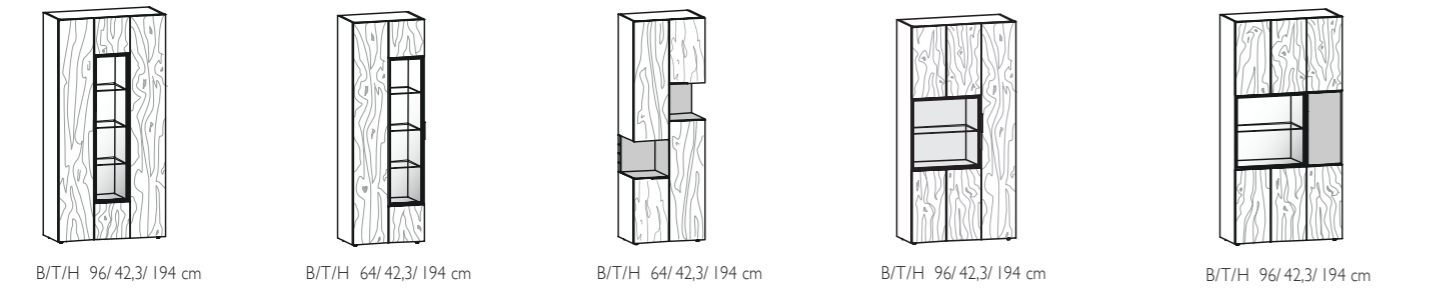

Lowboards

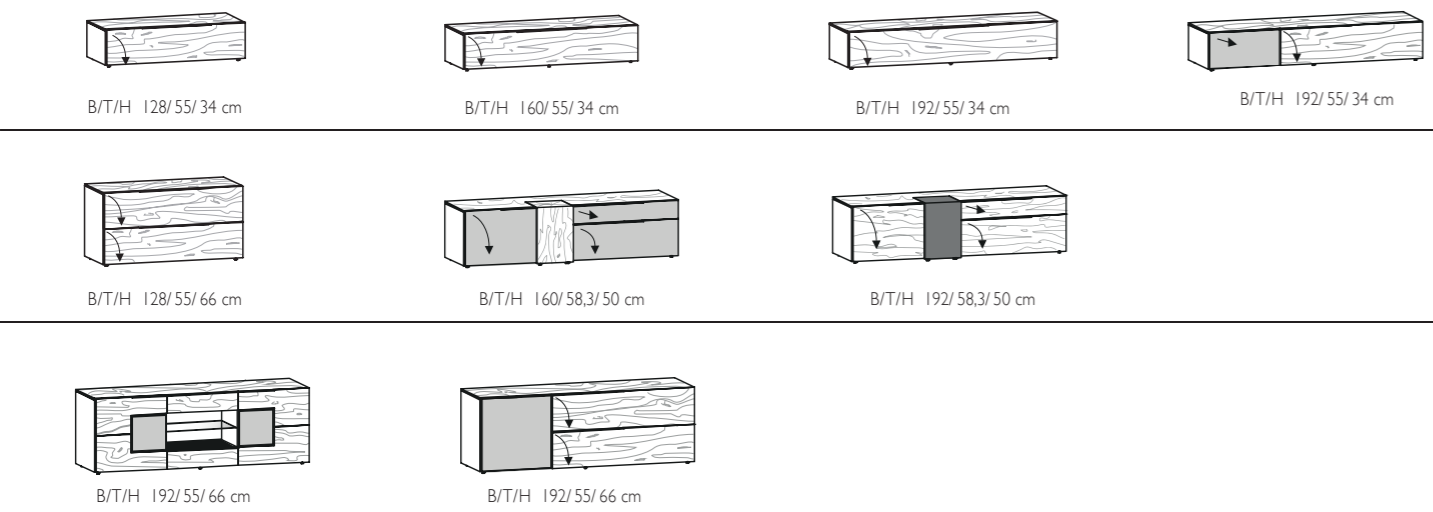

Mediaelemente

Alle Elemente auch spiegelbildlich lieferbar

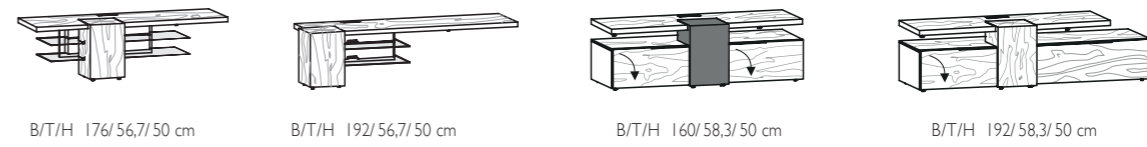

Wandpaneele

Wandborde



Hängeelemente

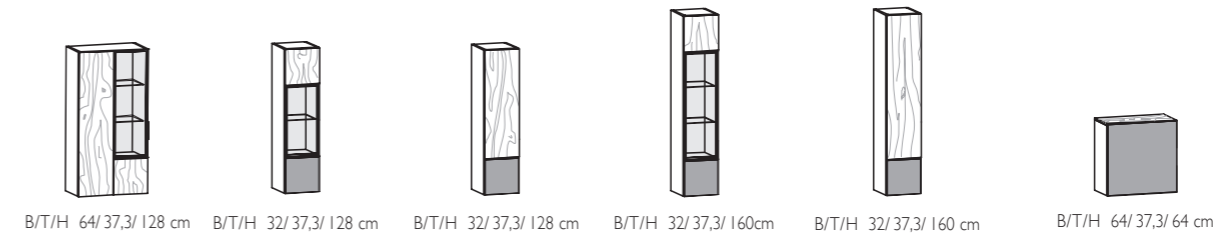

Hänge-Klappenelemente

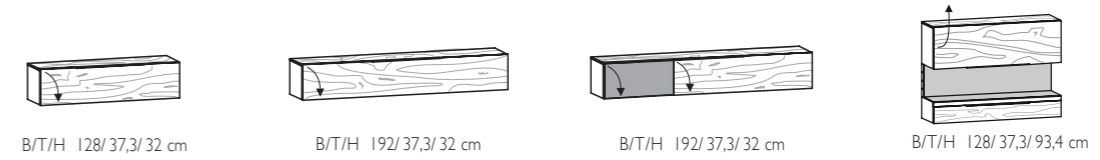

Couchtische

Platte um ca 21 cm
tum Anheben und
Verschieben

Wahlweise mit 1,2
oder ohne Lade möglich

höhenverstellbar
38,3 bis 74,3 cm



Kuben



Bänke



Tische

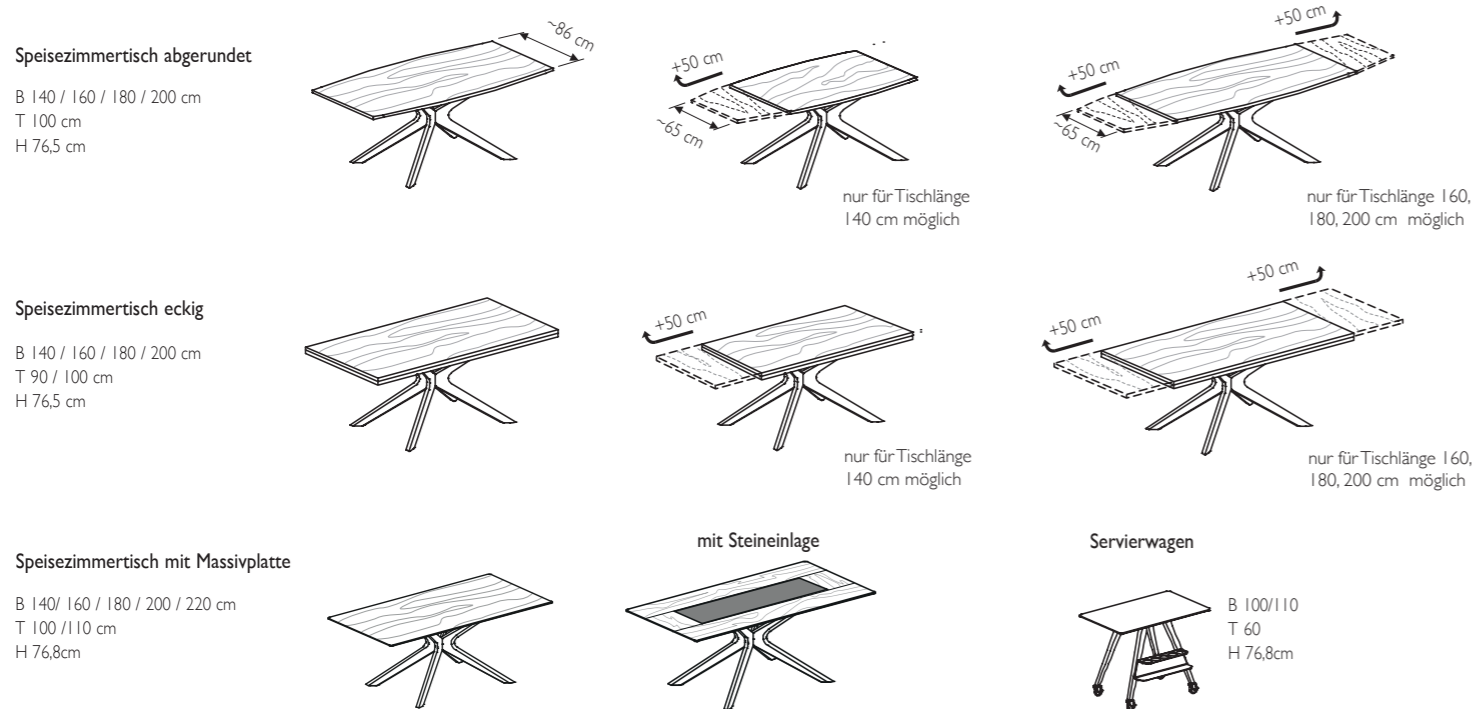

Stühle

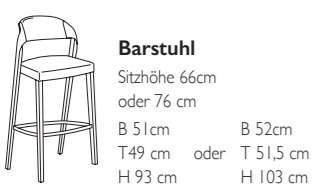
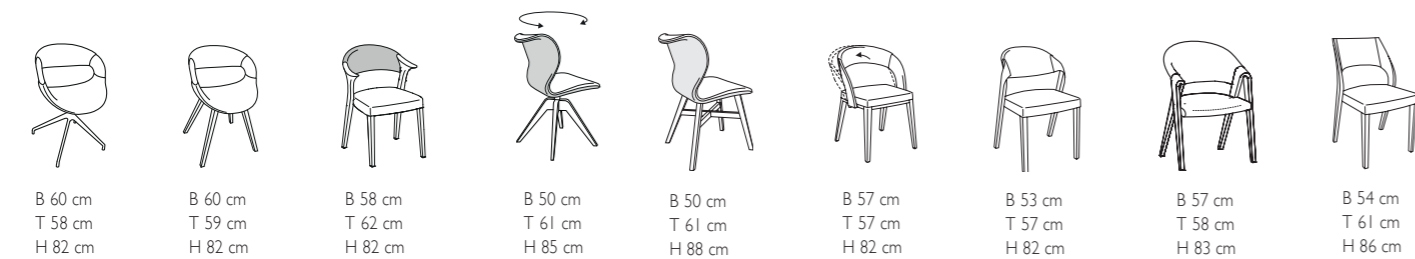

Die komplette Typenliste – alle Varianten und Typen – kann auf unserer Homepage heruntergeladen werden.

The complete type list can be downloaded on our homepage.

La liste complète de modèles peut être téléchargée sur notre site internet.

Wohnwandkombinationen

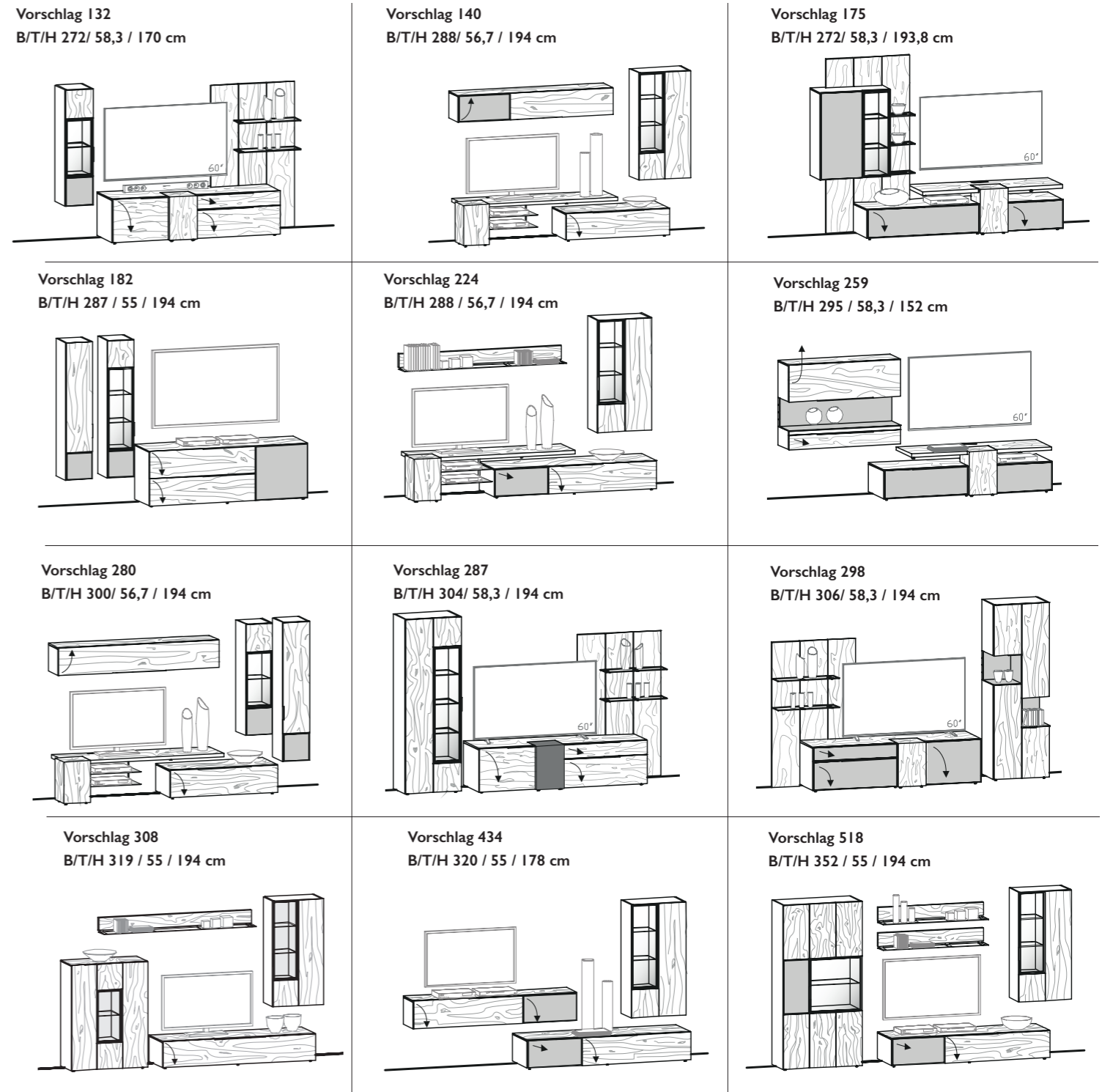

Alle Wohnwandvorschläge auch seitenverkehrt möglich!

Weitere Informationen über Typen und Varianten erhalten Sie bei unserem Möbelhandelspartner in Ihrer Nähe! Zu finden im Internet auf www.voglauer.com unter der Rubrik: „Händler“.

For more information about our furniture, please visit our nearest partner! You will find the list of our partners on our website www.voglauer.com, in the "Retailer" section.

Pour plus d'information concernant nos meubles, n'hésitez pas à aller voir notre partenaire le plus proche de chez vous! Vous trouverez la liste de nos partenaires sur notre site www.voglauer.com, dans la rubrique « Revendeurs ».

ALLE VOGLAUER MÖBELLINIEN



Wohnen/Speisen



Valpin



Vmontanara



Vrock living



Vtektura living



Schlafen



Valpin sleeping



Vmontanara sleeping



Vvaganto



Dielen



Valpin



Vmontanara



Vrock coming



Vtektura coming



Bad

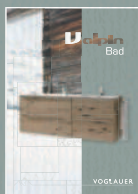

Valpin bad



Vmontanara bad



Vquell



Vlineos



Möbelgütepass
Gebrauchs- und Pflegeanweisung



Fordern Sie die gewünschten Folder telefonisch oder auf unserer Homepage an. Wir senden Ihnen diese gerne kostenlos zu.

Sie wollen mehr über unser Unternehmen oder unsere Produktlinien erfahren? Dann besuchen Sie uns im Internet unter www.voglauer.com



Abonnieren Sie uns auf unsere sozialen Medien. Hier werden Sie regelmäßig über aktuelle Entwicklungen und News rund um Voglauer informiert.

Voglauer Gschwandtner & Zwilling GmbH
Pichl 55, A-5441 Abtenau
Tel.: +43 (0) 6243 2700-0
office@voglauer.com | www.voglauer.com

Ihr Voglauer Einrichtungspartner: