

VOGLAUER

Ulineos



LIST OF TYPES
(valid from September 1, 2023)

Please always indicate the following specifications:

MODEL: LN | Vlineos Bad

WOOD:



SG | Old oak rustic grey lacquered



EH | Rustic oak varnished

STONE ACCENT

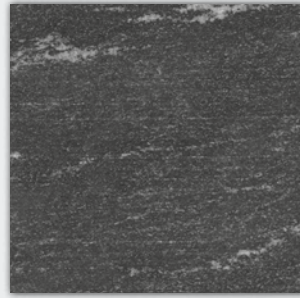

S | Alpengranit - schwarzgau

LIGHTING:



Surcharge:
Light color infinitely variable by touch sensor

SURFACE BASIN:



Countertop basin acrylic stone

UNDERCOUNTER WASHBASIN:

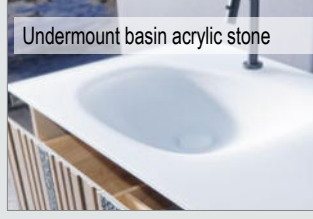

Undermount basin acrylic stone

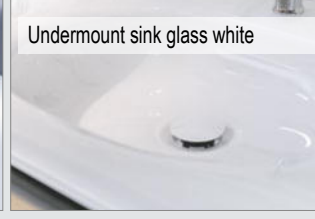

Undermount sink glass white

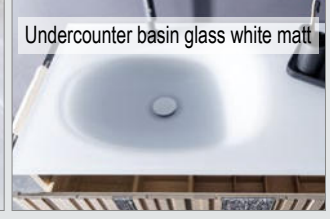

Undercounter basin glass white matt

Construction / loading capacities:

Carcass:	Carpenter board real wood veneer, solid wood (striped relief)			
Fronts:	Carpenter panel real wood veneer; solid wood (strip relief), crystal mirror, alpine granite black gau			
Accent:	stone accent alpine granite black-grey, aluminum profiles black anodized (C35)			
shelves:	glass shelves 6 mm, blockboard real wood veneered 20 mm			
Mirror handles:	Anodized stainless steel effect aluminum (EL02)			
Drawers:	dovetailed solid wooden drawers (oak) with concealed, easy-action fully extending pull-out			
Washbasins / basins:	Corian (acrylic stone) 12 mm, glass underside coated white			
Wood surface:	solvent-free water-based varnish with natural feel (SG including water-based stain).			
Loading capacities:	glass shelves 6 mm:	max. 5 kg	drawers up to 80 cm wide:	max. 10 kg
	wall units:	max. 50 kg	drawers over 80 cm wide:	max. 25 kg

Lighting (optional)

All lighting systems except surface mounted lights are permanently installed and wired into the furniture by VOGLAUER. Each illuminated element has an operating device or transformer and power cable. The lamps (bulbs) cannot be replaced in the luminaires. Switching with touch sensor switch with load memory function

Connection cable:	wall mirror 2.5 m with angled EURO plug, mirror units 1.5 m with angled earthed (Schuko) plug.
Power/consumption:	LED surface mounted lights: 20 watts, LED stripe (LED chains): 5 watts/running meter, LED-X-Line 5 watts/running meter.
Light color:	From 2700 Kelvin to 5000 Kelvin continuously adjustable

Energy consumption label: For all VOGLAUER furniture with lighting, the following applies: „This product contains a light source of **energy efficiency class F**“. The light source and associated control gear can only be replaced by qualified personnel.

Wood-based materials - indoor climate:

VOGLAUER bathroom furniture is suitable for a normal bathroom climate. Short periods of elevated humidity will not harm the furniture as long as humidity is allowed to escape by providing adequate ventilation (e.g. after showering). Splash water, condensation or stagnant moisture must therefore be removed immediately with a dry cloth as any prolonged exposure will lead to swelling damage or mould.

Despite meticulous craftsmanship, wood is a living raw material that reacts to changes in humidity and adapts to the prevailing climate. This may unavoidably result in colour and texture variations, minor cracks, slight warping or open knots. To reduce warping or cracks to a minimum, solid wooden furniture should be exposed to the smallest possible fluctuations in temperature or humidity. The surface is protected by several coats of high-quality lacquer. They should be cleaned with a damp cloth or a soft moist brush in the direction of grain. Dirt should not be allowed to dry on and must be removed straight away.

Washbasin units - Corian (acrylic stone):

Acrylic stone consisting of acrylic resin and minerals (two thirds) extracted from bauxite (aluminium ore). Acrylic resin – is a fully hardened material. Acrylic resin is produced entirely without styrenes and plasticisers and is also used for medical bone implants. Unlike marble or ceramic, acrylic stone washbasins cannot crack or flake. One of the many positive properties of acrylic stone is its non-porous surface. This property means that acrylic stone does not absorb any liquids or dirt. Acrylic stone is extremely dirt-repellent and resistant, making it very easy to look after.

Important planning information:

- To ensure proper fulfilment of the contract, all structural conditions, obstructions, dimensions and loads must be identified when ascertaining what is required.
- Identify the preliminary electrical work that is required for wiring and for connecting appliances (freely suspended lighting systems require surface-mounted or concealed cable ducting solutions). The mains power connection for lighting (socket, cable outlet) can be provided in the entire rear panel area behind the illuminated elements (rear-panel clearance for surface mirror approx. 32 mm, mirror cabinets approx. 23 mm).
- Electrified elements must have a distance of at least 60 cm from bath tub/shower. The safety regulations and standards applicable in the respective country must be observed.
- All units with hinged doors can only be installed with a clearance from the wall (as shown in the drawing) on the hinge side because as a result of the way in which they are designed, the doors protrude to the side on opening them.
- All dimensions stated in the product guide are theoretical approximate dimensions and may diverge from actual dimensions, especially as a result of cumulative tolerances. Handle or other insignificant component projections are not included in the overall dimensions.

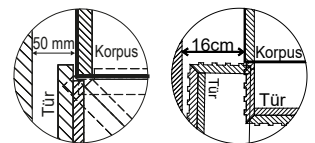





Installing furniture



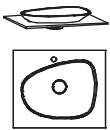
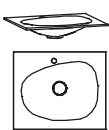
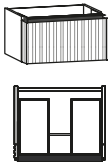
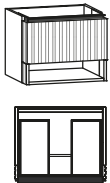
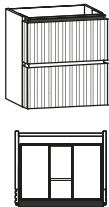
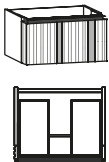
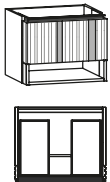
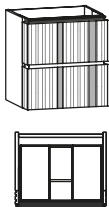

- All carcass elements must be fixed to the wall. VOGLAUER supplies the appropriate mounting accessories for solid brickwork or masonry. For stud walls, specialist fitters must obtain suitable wall plugs screws themselves. VOGLAUER assumes no liability for installation!
- Door hinges are nickel-plated and adjustable in 3 directions. However, for exact door fit, it is essential for furniture to be perfectly level and upright. Minor wall unevenness can be corrected with the mounting fittings. Any level differences resulting from protruding wall coverings, e.g. partial-height tiling, must be compensated for by means of suitable spacer profiles.
- The washbasin and base unit must be bonded together with a transparent, silicone-based neutral (solvent-free / neutrally cross-linking) joint sealant. Also use this joint sealant to protect all connection joints between the washbasin and adjacent components (joint requiring regular maintenance).



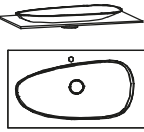
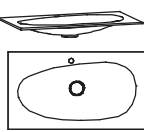
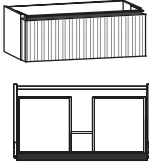
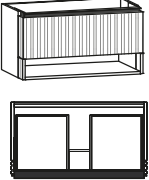
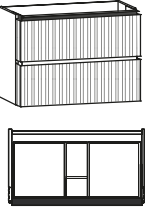
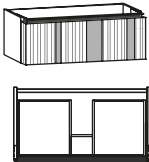
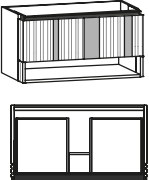
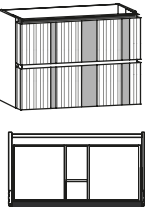

Remark: given their material properties, elastic joints must be regarded as maintenance joints requiring regular maintenance and are therefore not considered as sealing. The function of a joint requiring regular maintenance must be checked at regular intervals and the material must be replaced if necessary to avoid consequential damage. As the term implies, they require maintenance and have load limits. Joints requiring regular maintenance are not covered by the warranty!



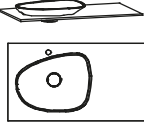
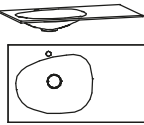
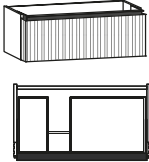
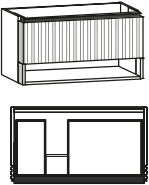
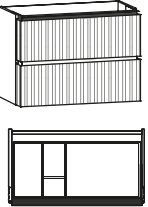
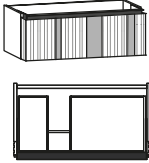
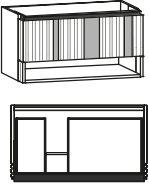
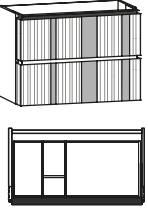

VOGLAUER furniture quality certificate:



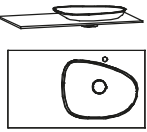
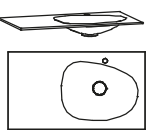
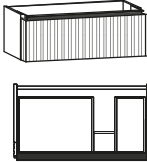
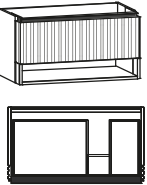
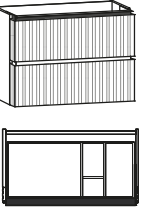
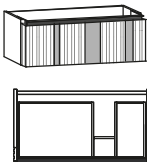
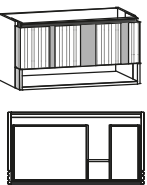
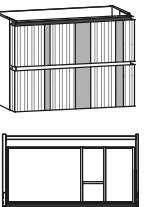

When buying VOGLAUER furniture, the VOGLAUER Furniture Quality Pass is handed over (online download: www.voglauder.com). A comprehensive documentation specifying the 5-year warranty and containing many important information such as instructions for use and care.



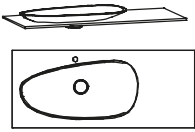
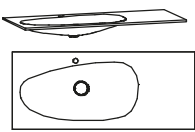
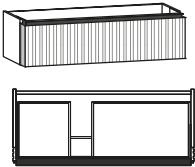
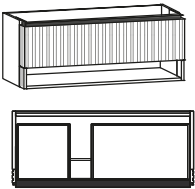
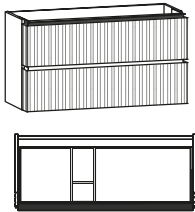
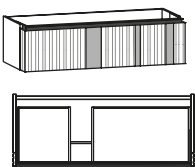
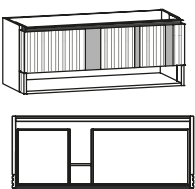
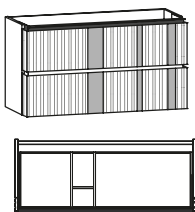

with 1 tap hole (available without tap hole on request)				
	W/D/H in cm: 65 / 55 / 12,6	W/D/H in cm: 65 / 55 / 13		
Description	furniture washbasin 65, countertop basin	furniture washbasin 65, undermount basin		
Washbasin	Acrylic stone white	Acrylic stone white	Glass white mat	Glass white
Item number	BW65MAK-AW	BW65MUK-AW	BW65MUK-GM	BW65MUK-GW
Surcharge Waste and overflow set with matching cover (CLOU system with lever for pop-up waste)	---	(-U1)		
Surcharge Permanent waste set with matching cover	(-P1)			
				
	W/D/H in cm: 64 / 53,7 / 34,8	W/D/H in cm: 64 / 53,7 / 50,8	W/D/H in cm: 64 / 53,7 / 68,8	
Description	Vanity unit 64/34, 1 drawer	Vanity unit 64/50, 1 drawer, open compartment	Vanity unit 64/68, 2 drawers	
Item number	W64M	W64MF	W64MH	
Oak SG or EH *				
Surcharge for lighting with touch sensor	(-W64U)			
				
	W/D/H in cm: 64 / 53,7 / 34,8	W/D/H in cm: 64 / 53,7 / 50,8	W/D/H in cm: 64 / 53,7 / 68,8	
Description	Vanity unit 64/34, 1 drawer, stone accent	Vanity unit 64/50, 1 drawer, open compartment, stone accent	Vanity unit 64/68, 2 drawers, stone accent	
Item number	W64MA	W64MFA	W64MHA	
Oak SG or EH *				
Surcharge for lighting with touch sensor	(-W64U)			
Suitable drawer inserts				
	W/D/H in cm: 19 / 37,6 / 5,5	W/D/H in cm: 18,6 / 37 / 7	W/D/H in cm: 18,6 / 37 / 7	
Description	Vanity drawer insert 19/37 cm	Make-up insert 19/38 cm	Make-up tray, wood 19/37 cm	
Item number	BVL19	BSE19	BSS19	

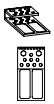

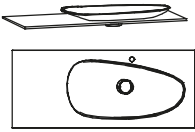
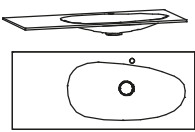
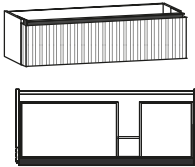
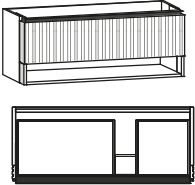
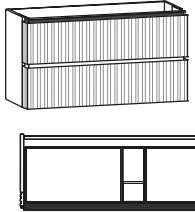
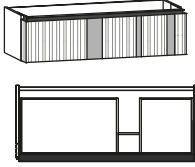
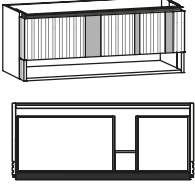
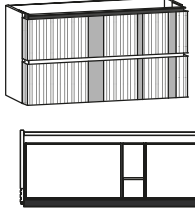

<p>with 1 tap hole (available without tap hole on request)</p>	 <p>W/D/H in cm: 97 / 55 / 12,6</p>	 <p>W/D/H in cm: 97 / 55 / 13</p>		
<p>Description</p>	<p>furniture washbasin 97, countertop basin</p>	<p>furniture washbasin 97, undermount basin</p>		
<p>Washbasin</p>	<p>Acrylic stone white</p>	<p>Acrylic stone white</p>	<p>Glass white mat</p>	<p>Glass white</p>
<p>Item number</p>	<p>BW97MAK-AW</p>	<p>BW97MUK-AW</p>	<p>BW97MUK-GM</p>	<p>BW97MUK-GW</p>
<p>Surcharge Waste and overflow set with matching cover (CLOU system with lever for pop-up waste)</p>	<p>---</p>	<p>(-U1)</p>		
<p>Surcharge Permanent waste set with matching cover</p>	<p>(-P1)</p>			
 <p>W/D/H in cm: 96 / 53,7 / 34,8</p>	 <p>W/D/H in cm: 96 / 53,7 / 50,8</p>	 <p>W/D/H in cm: 96 / 53,7 / 68,8</p>		
<p>Description</p>	<p>Vanity unit 96/34, 1 drawer</p>	<p>Vanity unit 96/50, 1 drawer, open compartment</p>	<p>Vanity unit 96/68, 2 drawers</p>	
<p>Item number</p>	<p>W96M</p>	<p>W96MF</p>	<p>W96MH</p>	
<p>Oak SG or EH *</p>				
<p>Surcharge lighting with touch sensor</p>	<p>(-W96U)</p>			
 <p>W/D/H in cm: 96 / 53,7 / 34,8</p>	 <p>W/D/H in cm: 96 / 53,7 / 50,8</p>	 <p>W/D/H in cm: 96 / 53,7 / 68,8</p>		
<p>Description</p>	<p>vanity unit 96/34, 1 drawer, stone accent</p>	<p>Vanity unit 96/50, 1 drawer, open compartment, stone accent</p>	<p>vanity unit 96/68, 2 drawers, stone accent</p>	
<p>Item number</p>	<p>W96MA</p>	<p>W96MFA</p>	<p>W96MHA</p>	
<p>Oak SG or EH *</p>				
<p>Surcharge lighting with touch sensor</p>	<p>(-W96U)</p>			
<p>Suitable drawer inserts</p>	 <p>W/D/H in cm: 35 / 37,6 / 5,5</p>	 <p>W/D/H in cm: 18,6 / 37 / 7</p>	 <p>W/D/H in cm: 18,6 / 37 / 7</p>	
<p>Description</p>	<p>Variable drawer insert 35/37 cm</p>	<p>Make-up insert 19/38 cm</p>	<p>Make-up tray, wood 19/37 cm</p>	
<p>Item number</p>	<p>BVL35</p>	<p>BSE19</p>	<p>BSS19</p>	



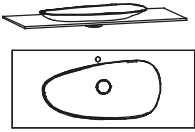
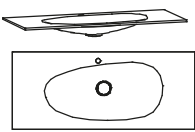
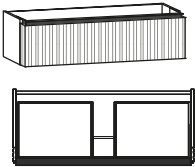
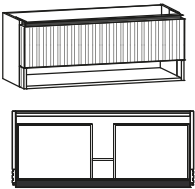
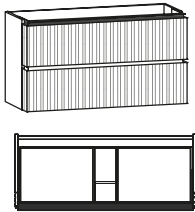
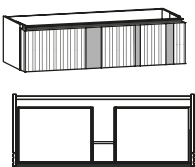
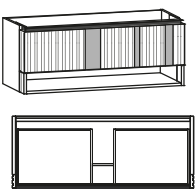
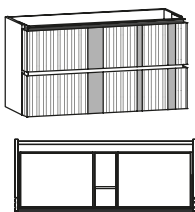

<p>with 1 tap hole (available without tap hole on request)</p>	 <p>W/D/H in cm: 97 / 55 / 12,6</p>	 <p>W/D/H in cm: 97 / 55 / 13</p>		
<p>Description</p>	<p>Furniture washbasin 97, countertop basin on the side, LH version</p>	<p>Furniture washbasin 97, undermount basin, lateral, LH version</p>		
<p>Washbasin</p>	<p>Acrylic stone white</p>	<p>Acrylic stone white</p>	<p>Glass white mat</p>	<p>Glass white</p>
<p>Item number</p>	<p>BW97EAK-AW-L</p>	<p>BW97EUK-AW-L</p>	<p>BW97EUK-GM-L</p>	<p>BW97EUK-GW-L</p>
<p>Surcharge Waste and overflow set with matching cover (CLOU system with lever for pop-up waste)</p>	<p>---</p>	<p>(-U1)</p>		
<p>Surcharge Permanent waste set with matching cover</p>	<p>(-P1)</p>			
 <p>W/D/H in cm: 96 / 53,7 / 34,8</p>	 <p>W/D/H in cm: 96 / 53,7 / 50,8</p>	 <p>W/D/H in cm: 96 / 53,7 / 68,8</p>		
<p>Description</p>	<p>Vanity unit 96/34, 1 drawer, LH version</p>	<p>Vanity unit 96/50, 1 drawer, open compartment, LH version</p>	<p>Vanity unit 96/68, 2 drawers, LH version</p>	
<p>Item number</p>	<p>W96E-L</p>	<p>W96EF-L</p>	<p>W96EH-L</p>	
<p>Oak SG or EH *</p>	<p>(-W96U)</p>			
<p>Surcharge lighting with touch sensor</p>	<p>(-W96U)</p>			
 <p>W/D/H in cm: 96 / 53,7 / 34,8</p>	 <p>W/D/H in cm: 96 / 53,7 / 50,8</p>	 <p>W/D/H in cm: 96 / 53,7 / 68,8</p>		
<p>Description</p>	<p>vanity unit 96/34, 1 drawer, stone accent, LH version</p>	<p>Vanity unit 96/50, 1 drawer, open compartment, stone accent, LH version</p>	<p>vanity unit 96/68, 2 drawers, stone accent, LH version</p>	
<p>Item number</p>	<p>W96EA-L</p>	<p>W96EFA-L</p>	<p>W96EHA-L</p>	
<p>Oak SG or EH *</p>	<p>(-W96U)</p>			
<p>Surcharge lighting with touch sensor</p>	<p>(-W96U)</p>			
<p>Suitable drawer inserts</p>	 <p>W/D/H in cm: 19 / 37,6 / 5,5</p>	 <p>W/D/H in cm: 51 / 37,6 / 5,5</p>	 <p>W/D/H in cm: 18,6 / 37 / 7</p>	 <p>W/D/H in cm: 18,6 / 37 / 7</p>
<p>Description</p>	<p>Vanity drawer insert 19/37 cm</p>	<p>Variable drawer insert 51/38 cm</p>	<p>Make-up insert 19/38 cm</p>	<p>Make-up tray, wood 19/37 cm</p>
<p>Item number</p>	<p>BVL19</p>	<p>BVL51</p>	<p>BSE19</p>	<p>BSS19</p>

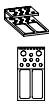

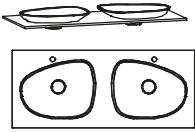
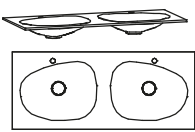
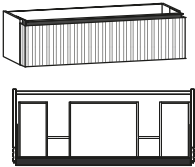
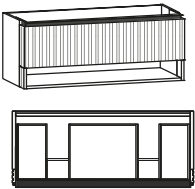
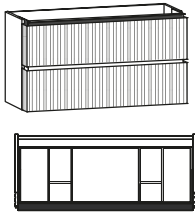
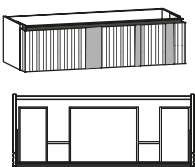
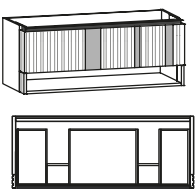
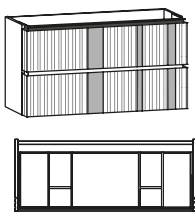

<p>with 1 tap hole (available without tap hole on request)</p>	 <p>W/D/H in cm: 97 / 55 / 12,6</p>	 <p>W/D/H in cm: 97 / 55 / 13</p>		
<p>Description</p>	<p>Furniture washbasin 97, countertop basin on the side, RH version</p>	<p>Furniture washbasin 97, undermount basin, lateral, RH version</p>		
<p>Washbasin</p>	<p>Acrylic stone white</p>	<p>Acrylic stone white</p>	<p>Glass white mat</p>	<p>Glass white</p>
<p>Item number</p>	<p>BW97EAK-AW-R</p>	<p>BW97EUK-AW-R</p>	<p>BW97EUK-GM-R</p>	<p>BW97EUK-GW-R</p>
<p>Surcharge Waste and overflow set with matching cover (CLOU system with lever for pop-up waste)</p>	<p>---</p>	<p>(-U1)</p>		
<p>Surcharge Permanent waste set with matching cover</p>	<p>(-P1)</p>			
 <p>W/D/H in cm: 96 / 53,7 / 34,8</p>	 <p>W/D/H in cm: 96 / 53,7 / 50,8</p>	 <p>W/D/H in cm: 96 / 53,7 / 68,8</p>		
<p>Description</p>	<p>Vanity unit 96/34, 1 drawer, RH version</p>	<p>Vanity unit 96/50, 1 drawer, open compartment, RH version</p>	<p>Vanity unit 96/68, 2 drawers, RH version</p>	
<p>Item number</p>	<p>W96E-R</p>	<p>W96EF-R</p>	<p>W96EH-R</p>	
<p>Oak SG or EH *</p>				
<p>Surcharge lighting with touch sensor</p>	<p>(-W96U)</p>			
 <p>W/D/H in cm: 96 / 53,7 / 34,8</p>	 <p>W/D/H in cm: 96 / 53,7 / 50,8</p>	 <p>W/D/H in cm: 96 / 53,7 / 68,8</p>		
<p>Description</p>	<p>vanity unit 96/34, 1 drawer, stone accent, RH version</p>	<p>Vanity unit 96/50, 1 drawer, open compartment, stone accent, RH version</p>	<p>vanity unit 96/68, 2 drawers, stone accent, RH version</p>	
<p>Item number</p>	<p>W96EA-R</p>	<p>W96EFA-R</p>	<p>W96EHA-R</p>	
<p>Oak SG or EH *</p>				
<p>Surcharge lighting with touch sensor</p>	<p>(-W96U)</p>			
<p>Suitable drawer inserts</p>	 <p>W/D/H in cm: 19 / 37,6 / 5,5</p>	 <p>W/D/H in cm: 51 / 37,6 / 5,5</p>	 <p>W/D/H in cm: 18,6 / 37 / 7</p>	 <p>W/D/H in cm: 18,6 / 37 / 7</p>
<p>Description</p>	<p>Vanity drawer insert 19/37 cm</p>	<p>Variable drawer insert 51/38 cm</p>	<p>Make-up insert 19/38 cm</p>	<p>Make-up tray, wood 19/37 cm</p>
<p>Item number</p>	<p>BVL19</p>	<p>BVL51</p>	<p>BSE19</p>	<p>BSS19</p>



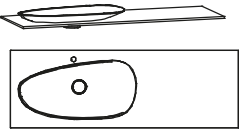
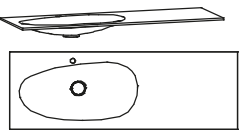
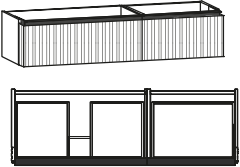
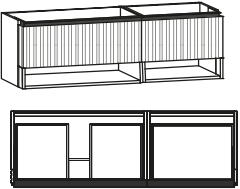
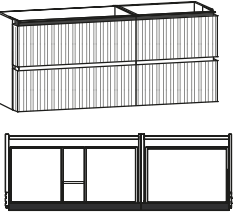
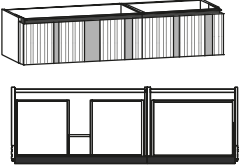
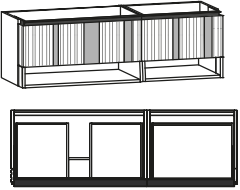
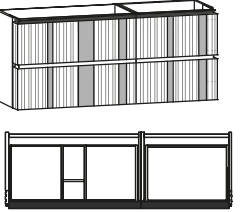

<p>with 1 tap hole (available without tap hole on request)</p>	 <p>W/D/H in cm: 129 / 55 / 12,6</p>	 <p>W/D/H in cm: 129 / 55 / 13</p>		
<p>Description</p>	<p>Furniture washbasin 129, countertop basin on the side, LH version</p>	<p>Furniture washbasin 129, undermount basin on the side, LH version</p>		
<p>Washbasin</p>	<p>Acrylic stone white</p>	<p>Acrylic stone white</p>	<p>Glass white mat</p>	<p>Glass white</p>
<p>Item number</p>	<p>BW12EAK-AW-L</p>	<p>BW12EUK-AW-L</p>	<p>BW12EUK-GM-L</p>	<p>BW12EUK-GW-L</p>
<p>Surcharge Waste and overflow set with matching cover (CLOU system with lever for pop-up waste)</p>	<p>---</p>	<p>(-U1)</p>		
<p>Surcharge Permanent waste set with matching cover</p>	<p>(-P1)</p>			
 <p>W/D/H in cm: 128 / 53,7 / 34,8</p>	 <p>W/D/H in cm: 128 / 53,7 / 50,8</p>	 <p>W/D/H in cm: 128 / 53,7 / 68,8</p>		
<p>Description</p>	<p>Vanity unit 128/34, 1 drawer, LH version</p>	<p>vanity unit 128/50, 1 drawer, open compartment, LH version</p>	<p>Vanity unit 128/68, 2 drawers, LH version</p>	
<p>Item number</p>	<p>W12E-L</p>	<p>W12EF-L</p>	<p>W12EH-L</p>	
<p>Oak SG or EH *</p>	<p>(-W12U)</p>			
<p>Surcharge lighting with touch sensor</p>	<p>(-W12U)</p>			
 <p>W/D/H in cm: 128 / 53,7 / 34,8</p>	 <p>W/D/H in cm: 128 / 53,7 / 50,8</p>	 <p>W/D/H in cm: 128 / 53,7 / 68,8</p>		
<p>Description</p>	<p>vanity unit 128/34, 1 drawer, stone accent, LH version</p>	<p>Vanity unit 128/50, 1 drawer, open compartment, stone accent, LH version</p>	<p>vanity unit 128/68, 2 drawers, stone accent, LH version</p>	
<p>Item number</p>	<p>W12EA-L</p>	<p>W12EFA-L</p>	<p>W12EHA-L</p>	
<p>Oak SG or EH *</p>	<p>(-W12U)</p>			
<p>Surcharge lighting with touch sensor</p>	<p>(-W12U)</p>			
<p>Suitable drawer inserts</p>	 <p>W/D/H in cm: 35 / 37,6 / 5,5</p>	 <p>W/D/H in cm: 18,6 / 37 / 7</p>	 <p>W/D/H in cm: 18,6 / 37 / 7</p>	
<p>Description</p>	<p>Variable drawer insert 35/37 cm</p>	<p>Make-up insert 19/38 cm</p>	<p>Make-up tray, wood 19/37 cm</p>	
<p>Item number</p>	<p>BVL35</p>	<p>BSE19</p>	<p>BSS19</p>	

<p>with 1 tap hole (available without tap hole on request)</p>	 <p>W/D/H in cm: 129 / 55 / 12,6</p>	 <p>W/D/H in cm: 129 / 55 / 13</p>		
<p>Description</p>	<p>Furniture washbasin 129, countertop basin on the side, RH version</p>	<p>Furniture washbasin 129, undermount basin on the side, RH version</p>		
<p>Washbasin</p>	<p>Acrylic stone white</p>	<p>Acrylic stone white</p>	<p>Glass white mat</p>	<p>Glass white</p>
<p>Item number</p>	<p>BW12EAK-AW-R</p>	<p>BW12EUK-AW-R</p>	<p>BW12EUK-GM-R</p>	<p>BW12EUK-GW-R</p>
<p>Surcharge Waste and overflow set with matching cover (CLOU system with lever for pop-up waste)</p>	<p>---</p>	<p>(-U1)</p>		
<p>Surcharge Permanent waste set with matching cover</p>	<p>(-P1)</p>			
 <p>W/D/H in cm: 128 / 53,7 / 34,8</p>	 <p>W/D/H in cm: 128 / 53,7 / 50,8</p>	 <p>W/D/H in cm: 128 / 53,7 / 68,8</p>		
<p>Description</p>	<p>Vanity unit 128/34, 1 drawer, RH version</p>	<p>vanity unit 128/50, 1 drawer, open compartment, RH version</p>	<p>Vanity unit 128/68, 2 drawers, RH version</p>	
<p>Item number</p>	<p>W12E-R</p>	<p>W12EF-R</p>	<p>W12EH-R</p>	
<p>Oak SG or EH *</p>	<p>(-W12U)</p>			
<p>Surcharge lighting with touch sensor</p>	<p>(-W12U)</p>			
 <p>W/D/H in cm: 128 / 53,7 / 34,8</p>	 <p>W/D/H in cm: 128 / 53,7 / 50,8</p>	 <p>W/D/H in cm: 128 / 53,7 / 68,8</p>		
<p>Description</p>	<p>vanity unit 128/34, 1 drawer, stone accent, RH version</p>	<p>Vanity unit 128/50, 1 drawer, open compartment, stone accent, RH version</p>	<p>vanity unit 128/68, 2 drawers, stone accent, RH version</p>	
<p>Item number</p>	<p>W12EA-R</p>	<p>W12EFA-R</p>	<p>W12EHA-R</p>	
<p>Oak SG or EH *</p>	<p>(-W12U)</p>			
<p>Surcharge lighting with touch sensor</p>	<p>(-W12U)</p>			
<p>Suitable drawer inserts</p>	 <p>W/D/H in cm: 35 / 37,6 / 5,5</p>	 <p>W/D/H in cm: 18,6 / 37 / 7</p>	 <p>W/D/H in cm: 18,6 / 37 / 7</p>	
<p>Description</p>	<p>Variable drawer insert 35/37 cm</p>	<p>Make-up insert 19/38 cm</p>	<p>Make-up tray, wood 19/37 cm</p>	
<p>Item number</p>	<p>BVL35</p>	<p>BSE19</p>	<p>BSS19</p>	

<p>with 1 tap hole (available without tap hole on request)</p>	 <p>W/D/H in cm: 129 / 55 / 12,6</p>	 <p>W/D/H in cm: 129 / 55 / 13</p>		
<p>Description</p>	<p>furniture washbasin 129, countertop basin</p>	<p>furniture washbasin 129, undermount basin</p>		
<p>Washbasin</p>	<p>Acrylic stone white</p>	<p>Acrylic stone white</p>	<p>Glass white mat</p>	<p>Glass white</p>
<p>Item number</p>	<p>BW12MAK-AW</p>	<p>BW12MUK-AW</p>	<p>BW12MUK-GM</p>	<p>BW12MUK-GW</p>
<p>Surcharge Waste and overflow set with matching cover (CLOU system with lever for pop-up waste)</p>	<p>---</p>	<p>(-U1)</p>		
<p>Surcharge Permanent waste set with matching cover</p>	<p>(-P1)</p>			
 <p>W/D/H in cm: 128 / 53,7 / 34,8</p>	 <p>W/D/H in cm: 128 / 53,7 / 50,8</p>	 <p>W/D/H in cm: 128 / 53,7 / 68,8</p>		
<p>Description</p>	<p>Vanity unit 128/34, 1 drawer</p>	<p>vanity unit 128/50, 1 drawer, open compartment</p>	<p>Vanity unit 128/68, 2 drawers</p>	
<p>Item number</p>	<p>W12M</p>	<p>W12MF</p>	<p>W12MH</p>	
<p>Oak SG or EH *</p>				
<p>Surcharge lighting with touch sensor</p>	<p>(-W12U)</p>			
 <p>W/D/H in cm: 128 / 53,7 / 34,8</p>	 <p>W/D/H in cm: 128 / 53,7 / 50,8</p>	 <p>W/D/H in cm: 128 / 53,7 / 68,8</p>		
<p>Description</p>	<p>vanity unit 128/34, 1 drawer, stone accent</p>	<p>Vanity unit 128/50, 1 drawer, open compartment, stone accent</p>	<p>vanity unit 128/68, 2 drawers, stone accent</p>	
<p>Item number</p>	<p>W12MA</p>	<p>W12MFA</p>	<p>W12MHA</p>	
<p>Oak SG or EH *</p>				
<p>Surcharge lighting with touch sensor</p>	<p>(-W12U)</p>			
<p>Suitable drawer inserts</p>	 <p>W/D/H in cm: 51 / 37,6 / 5,5</p>	 <p>W/D/H in cm: 18,6 / 37 / 7</p>	 <p>W/D/H in cm: 18,6 / 37 / 7</p>	
<p>Description</p>	<p>Variable drawer insert 51/38 cm</p>	<p>Make-up insert 19/38 cm</p>	<p>Make-up tray, wood 19/37 cm</p>	
<p>Item number</p>	<p>BVL51</p>	<p>BSE19</p>	<p>BSS19</p>	

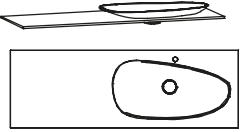
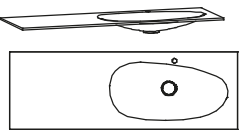
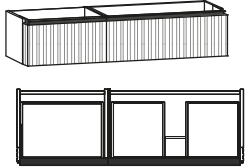
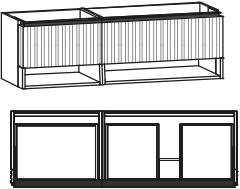
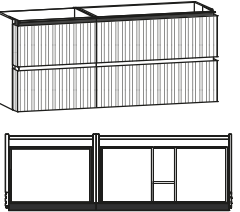
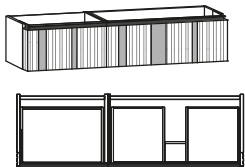
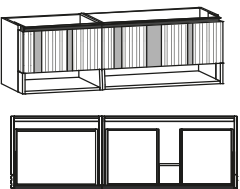
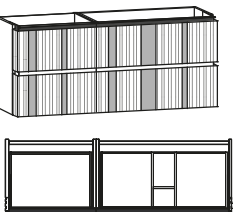
<p>with 2 tap holes (available without tap holes on request)</p>	 <p>W/D/H in cm: 129 / 55 / 12,6</p>	 <p>W/D/H in cm: 129 / 55 / 13</p>		
<p>Description</p>	<p>Double furniture washbasin 129, countertop basin</p>	<p>Double furniture washbasin 129, undermount basin</p>		
<p>Washbasin</p>	<p>Acrylic stone white</p>	<p>Acrylic stone white</p>	<p>Glass white mat</p>	<p>Glass white</p>
<p>Item number</p>	<p>BW12DAK-AW</p>	<p>BW12DUK-AW</p>	<p>BW12DUK-GM</p>	<p>BW12DUK-GW</p>
<p>Surcharge 2 waste and overflow sets with matching cover (CLOU system with lever for pop-up waste)</p>	<p>---</p>	<p>(-U2)</p>		
<p>2x permanent drain set with matching cover</p>	<p>(-P2)</p>			
 <p>W/D/H in cm: 128 / 53,7 / 34,8</p>	 <p>W/D/H in cm: 128 / 53,7 / 50,8</p>	 <p>W/D/H in cm: 128 / 53,7 / 68,8</p>		
<p>Description</p>	<p>Double washbasin cabinet 128/34, 1 drawer</p>	<p>Double vanity unit 128/50, 1 drawer, open compartment</p>	<p>double vanity unit 128/68, 2 drawers</p>	
<p>Item number</p>	<p>W12D</p>	<p>W12DF</p>	<p>W12DH</p>	
<p>Oak SG or EH *</p>				
<p>Surcharge lighting with touch sensor</p>	<p>(-W12U)</p>			
 <p>W/D/H in cm: 128 / 53,7 / 34,8</p>	 <p>W/D/H in cm: 128 / 53,7 / 50,8</p>	 <p>W/D/H in cm: 128 / 53,7 / 68,8</p>		
<p>Description</p>	<p>Double washbasin cabinet 128/34, 1 drawer, stone accent</p>	<p>double vanity unit 128/50, 1 drawer, open compartment, stone accent</p>	<p>double vanity unit 128/68, 2 drawers, stone accent</p>	
<p>Item number</p>	<p>W12DA</p>	<p>W12DFA</p>	<p>W12DHA</p>	
<p>Oak SG or EH *</p>				
<p>Surcharge lighting with touch sensor</p>	<p>(-W12U)</p>			
<p>Suitable drawer inserts</p>	 <p>W/D/H in cm: 19 / 37,6 / 5,5</p>	 <p>W/D/H in cm: 18,6 / 37 / 7</p>	 <p>W/D/H in cm: 18,6 / 37 / 7</p>	
<p>Description</p>	<p>Vanity drawer insert 19/37 cm</p>	<p>Make-up insert 19/38 cm</p>	<p>Make-up tray, wood 19/37 cm</p>	
<p>Item number</p>	<p>BVL19</p>	<p>BSE19</p>	<p>BSS19</p>	



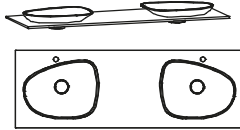
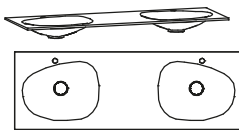

<p>with 1 tap hole (available without tap hole on request)</p>	 <p>W/D/H in cm: 161 / 55 / 12,6</p>	 <p>W/D/H in cm: 161 / 55 / 13</p>		
<p>Description</p>	<p>furniture washbasin 161, countertop basin on the side, LH version</p>	<p>Furniture washbasin 1610, undermount basin on the side, LH version</p>		
<p>Washbasin</p>	<p>Acrylic stone white</p>	<p>Acrylic stone white</p>	<p>Glass white mat</p>	<p>Glass white</p>
<p>Item number</p>	<p>BW16EAK-AW-L</p>	<p>BW16EUK-AW-L</p>	<p>BW16EUK-GM-L</p>	<p>BW16EUK-GW-L</p>
<p>Surcharge Waste and overflow set with matching cover (CLOU system with lever for pop-up waste)</p>	<p>---</p>	<p>(-U1)</p>		
<p>Surcharge Permanent waste set with matching cover</p>	<p>(-P1)</p>			
 <p>W/D/H in cm: 160 / 53,7 / 34,8</p>	 <p>W/D/H in cm: 160 / 53,7 / 50,8</p>	 <p>W/D/H in cm: 160 / 53,7 / 68,8</p>		
<p>Description</p>	<p>Vanity unit 160/34, 2 drawers, LH version</p>	<p>vanity unit 160/50, 2 drawers, open compartment, LH version</p>	<p>Vanity unit 160/68, 4 drawers, LH version</p>	
<p>Item number</p>	<p>W16E-L</p>	<p>W16EF-L</p>	<p>W16EH-L</p>	
<p>Oak SG or EH *</p>	<p>(-W16U)</p>			
<p>Surcharge lighting with touch sensor</p>	<p>(-W16U)</p>			
 <p>W/D/H in cm: 160 / 53,7 / 34,8</p>	 <p>W/D/H in cm: 160 / 53,7 / 50,8</p>	 <p>W/D/H in cm: 160 / 53,7 / 68,8</p>		
<p>Description</p>	<p>vanity unit 160/34, 2 drawers, stone accent, LH version</p>	<p>vanity unit 160/50, 2 drawers, open compartment, stone accent, LH version</p>	<p>vanity unit 160/68, 4 drawers, stone accent, LH version</p>	
<p>Item number</p>	<p>W16EA-L</p>	<p>W16EFA-L</p>	<p>W16EHA-L</p>	
<p>Oak SG or EH *</p>	<p>(-W16U)</p>			
<p>Surcharge lighting with touch sensor</p>	<p>(-W16U)</p>			
<p>Suitable drawer inserts</p>	 <p>W/D/H in cm: 35 / 37,6 / 5,5</p>	 <p>W/D/H in cm: 18,6 / 37 / 7</p>	 <p>W/D/H in cm: 18,6 / 37 / 7</p>	
<p>Description</p>	<p>Variable drawer insert 35/37 cm</p>	<p>Make-up insert 19/38 cm</p>	<p>Make-up tray, wood 19/37 cm</p>	
<p>Item number</p>	<p>BVL35</p>	<p>BSE19</p>	<p>BSS19</p>	

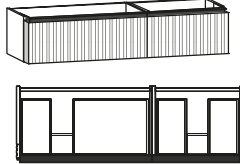
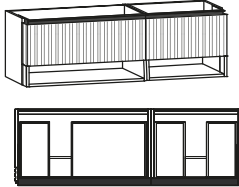
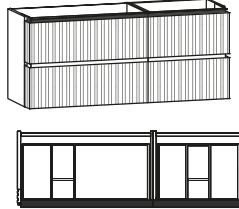

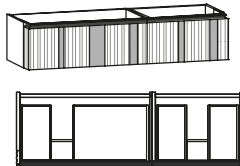
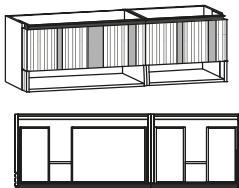
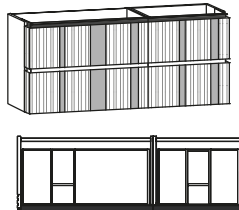













<p>with 1 tap hole (available without tap hole on request)</p>	 <p>W/D/H in cm: 161 / 55 / 12,6</p>	 <p>W/D/H in cm: 161 / 55 / 13</p>		
<p>Description</p>	<p>furniture washbasin 161, countertop basin on the side, RH version</p>	<p>Furniture washbasin 1610, undermount basin on the side, RH version</p>		
<p>Washbasin</p>	<p>Acrylic stone white</p>	<p>Acrylic stone white</p>	<p>Glass white mat</p>	<p>Glass white</p>
<p>Item number</p>	<p>BW16EAK-AW-R</p>	<p>BW16EUK-AW-R</p>	<p>BW16EUK-GM-R</p>	<p>BW16EUK-GW-R</p>
<p>Surcharge Waste and overflow set with matching cover (CLOU system with lever for pop-up waste)</p>	<p>---</p>	<p>(-U1)</p>		
<p>Surcharge Permanent waste set with matching cover</p>	<p>(-P1)</p>			
 <p>W/D/H in cm: 160 / 53,7 / 34,8</p>	 <p>W/D/H in cm: 160 / 53,7 / 50,8</p>	 <p>W/D/H in cm: 160 / 53,7 / 68,8</p>		
<p>Description</p>	<p>Vanity unit 160/34, 2 drawers, RH version</p>	<p>vanity unit 160/50, 2 drawers, open compartment, RH version</p>	<p>Vanity unit 160/68, 4 drawers, RH version</p>	
<p>Item number</p>	<p>W16E-R</p>	<p>W16EF-R</p>	<p>W16EH-R</p>	
<p>Oak SG or EH *</p>	<p>(-W16U)</p>			
<p>Surcharge lighting with touch sensor</p>	<p>(-W16U)</p>			
 <p>W/D/H in cm: 160 / 53,7 / 34,8</p>	 <p>W/D/H in cm: 160 / 53,7 / 50,8</p>	 <p>W/D/H in cm: 160 / 53,7 / 68,8</p>		
<p>Description</p>	<p>vanity unit 160/34, 2 drawers, stone accent, RH version</p>	<p>vanity unit 160/50, 2 drawers, open compartment, stone accent, RH version</p>	<p>vanity unit 160/68, 4 drawers, stone accent, RH version</p>	
<p>Item number</p>	<p>W16EA-R</p>	<p>W16EFA-R</p>	<p>W16EHA-R</p>	
<p>Oak SG or EH *</p>	<p>(-W16U)</p>			
<p>Surcharge lighting with touch sensor</p>	<p>(-W16U)</p>			
<p>Suitable drawer inserts</p>	 <p>W/D/H in cm: 35 / 37,6 / 5,5</p>	 <p>W/D/H in cm: 18,6 / 37 / 7</p>	 <p>W/D/H in cm: 18,6 / 37 / 7</p>	
<p>Description</p>	<p>Variable drawer insert 35/37 cm</p>	<p>Make-up insert 19/38 cm</p>	<p>Make-up tray, wood 19/37 cm</p>	
<p>Item number</p>	<p>BVL35</p>	<p>BSE19</p>	<p>BSS19</p>	

with 2 tap holes (available without tap holes on request)				
	W/D/H in cm: 161 / 55 / 12,6	W/D/H in cm: 161 / 55 / 13		
Description	double furniture washbasin 161, countertop basin	double furniture washbasin 161, undermount basin		
Washbasin	Acrylic stone white	Acrylic stone white	Glass white mat	Glass white
Item number	BW16DAK-AW	BW16DUK-AW	BW16DUK-GM	BW16DUK-GW
Surcharge 2 waste and overflow sets with matching cover (CLOU system with lever for pop-up waste)	---	(-U2)		
2x permanent drain set with matching cover	(-P2)			

			
W/D/H in cm: 160 / 53,7 / 34,8	W/D/H in cm: 160 / 53,7 / 50,8	W/D/H in cm: 160 / 53,7 / 68,8	
Description	Double vanity unit 160/34, 2 drawers	Double vanity unit 160/50, 2 drawers, open compartment	double vanity unit 160/68, 4 drawers
Item number	W16D	W16DF	W16DH
Oak SG or EH *			
Surcharge lighting with touch sensor	(-W16U)		



			
W/D/H in cm: 160 / 53,7 / 34,8	W/D/H in cm: 160 / 53,7 / 50,8	W/D/H in cm: 160 / 53,7 / 68,8	
Description	Double vanity unit 160/34, 2 drawers, stone accent	double vanity unit 160/50, 2 drawers, open compartment, stone accent	double vanity unit 160/68, 4 drawers, stone accent
Item number	W16DA	W16DFA	W16DHA
Oak SG or EH *			
Surcharge lighting with touch sensor	(-W16U)		

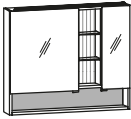
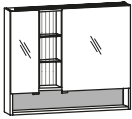
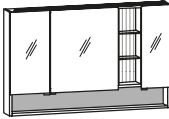
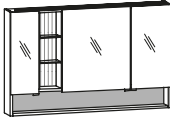

Suitable drawer inserts				
	W/D/H in cm: 19 / 37,6 / 5,5	W/D/H in cm: 51 / 37,6 / 5,5	W/D/H in cm: 18,6 / 37 / 7	W/D/H in cm: 18,6 / 37 / 7
Description	Vanity drawer insert 19/37 cm	Variable drawer insert 51/38 cm	Make-up insert 19/38 cm	Make-up tray, wood 19/37 cm
Item number	BVL19	BVL51	BSE19	BSS19

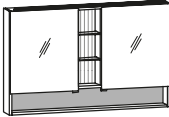
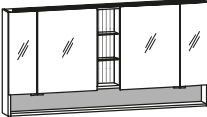

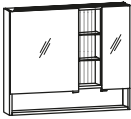
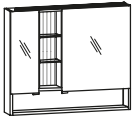
	 W/D/H in cm: 64 / 5,2 / 64	 W/D/H in cm: 96 / 5,2 / 64	 W/D/H in cm: 128 / 5,2 / 64	 W/D/H in cm: 160 / 5,2 / 64
Description	Mirror 64/64, top-mounted light	mirror 96/64, surface mounted lamp	Mirror 128/64, surface mounted light	Mirror 160/64, surface mounted light
Item number	SP64AU	SP96AU	SP12AU	SP16AU
Oak SG or EH *				
Surcharge for washbasin aera lighting	(-W64)	(-W96)	(-W12)	(-W16)
	1 Middle side 2 adjustable glass shelves each 1 double internal socket  W/D/H in cm: 64 / 16,2 / 64	1 Middle side 2 adjustable glass shelves each 1 double internal socket  W/D/H in cm: 96 / 16,2 / 64	2 middle sides 2 adjustable glass shelves each 1 double internal socket  W/D/H in cm: 128 / 16,2 / 64	3 middle sides 2 adjustable glass shelves each 1 double internal socket  W/D/H in cm: 160 / 16,2 / 64
Description	Mirror cabinet 64/64, 2-door, top-mounted light	mirror cabinet 96/64, 2-door, surface mounted lamp	mirror cabinet 128/64, 3-door, surface mounted lamp	mirror cabinet 160/64, 4-door, surface mounted lamp
Item number	SS64AU	SS96AU	SS12AU	SS16AU
Oak SG or EH *				
Surcharge for washbasin aera lighting	(-W64)	(-W96)	(-W12)	(-W16)
Surcharge makeup mirror	(SP)			
	1 Middle side 2 adjustable glass shelves each 1 double internal socket  W/D/H in cm: 64 / 16,2 / 80	1 Middle side 2 adjustable glass shelves each 1 double internal socket  W/D/H in cm: 96 / 16,2 / 80	2 middle sides 2 adjustable glass shelves each 1 double internal socket  W/D/H in cm: 128 / 16,2 / 80	3 middle sides 2 adjustable glass shelves each 1 double internal socket  W/D/H in cm: 160 / 16,2 / 80
Description	Mirror cabinet with shelf 64/80, 2-door, top-mounted light	mirror cabinet with shelf 96/80, 2-door, surface mounted lamp	Mirror cabinet with shelf 128/80, 3-door, surface mounted lamp	Mirror cabinet with shelf 160/80, 4-door, surface mounted lamp
Item number	SE64H	SE96H	SE12H	SE16H
Oak SG or EH *				
Surcharge for washbasin aera lighting	(-W64)	(-W96)	(-W12)	(-W16)
Surcharge makeup mirror	(SP)			
	1 Middle side 2 adjustable glass shelves each 1 double internal socket  W/D/H in cm: 64 / 16,2 / 80	1 Middle side 2 adjustable glass shelves each 1 double internal socket  W/D/H in cm: 96 / 16,2 / 80	2 middle sides 2 adjustable glass shelves each 1 double internal socket  W/D/H in cm: 128 / 16,2 / 80	3 middle sides 2 adjustable glass shelves each 1 double internal socket  W/D/H in cm: 160 / 16,2 / 80
Description	mirror cabinet with shelf 64/80, 2-door, mounted light, stone accent	mirror cabinet with shelf 96/80, 2-door, mounted light, stone accent	mirror cabinet with shelf 128/80, 3-door, mounted light, stone accent	Mirror cabinet with shelf 160/80, 4-door, surface mounted lamp
Item number	SE64	SE96	SE12	SE16
Oak SG or EH *				
Surcharge for washbasin aera lighting	(-W64)	(-W96)	(-W12)	(-W16)
Surcharge makeup mirror	(SP)			

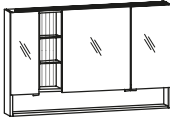
	2 adjustable glass shelves each 1 double internal socket 	2 adjustable glass shelves each 1 double internal socket 	Left 1 Centre panel 2 adjustable glass shelves each 1 double internal socket 	Right 1 Centre panel 2 adjustable glass shelves each 1 double internal socket 
	W/D/H in cm: 96 / 16,2 / 80	W/D/H in cm: 96 / 16,2 / 80	W/D/H in cm: 128 / 16,2 / 80	W/D/H in cm: 128 / 16,2 / 80
Description	mirror cabinet 96/80, one-sided shelf, built-on, stone accent, LH version	mirror cabinet 96/80, one-sided shelf, built-on, stone accent, RH version	Mirror cabinet 128/80, shelf on one side, mounted light, stone accent, LH version	Mirror cabinet 128/80, shelf on one side, mounted light, stone accent, RH version
Item number	SG96E-L	SG96E-R	SG12E-L	SG12E-R
Oak SG or EH *				
Surcharge for washbasin aera lighting	(-W96)	(-W96)	(-W12)	(-W12)
Surcharge makeup mirror	(-SP)			

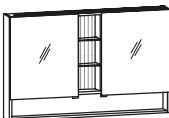
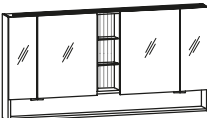
	2 adjustable glass shelves each 1 double internal socket 	2 middle sides 2 adjustable glass shelves each 1 double internal socket 	
	W/D/H in cm: 128 / 16,2 / 80	W/D/H in cm: 160 / 16,2 / 80	
Description	Mirrored cabinet 128/80, center shelf, mounted light, stone accent	mirror cabinet 160/80, center shelf, built-on, stone accent	
Item number	SG12M	SG16M	
Oak SG or EH *			
Surcharge for washbasin aera lighting	(-W12)	(-W16)	
Surcharge makeup mirror	(-SP)		

	2 adjustable glass shelves each 1 double internal socket 	2 adjustable glass shelves each 1 double internal socket 	Left 1 Centre panel 2 adjustable glass shelves each 1 double internal socket 	Right 1 Centre panel 2 adjustable glass shelves each 1 double internal socket 
	W/D/H in cm: 96 / 16,2 / 80	W/D/H in cm: 96 / 16,2 / 80	W/D/H in cm: 128 / 16,2 / 80	W/D/H in cm: 128 / 16,2 / 80
Description	mirror cabinet with one-sided shelf 96/80, surface mounted lamp, LH version	mirror cabinet with one-sided shelf 96/80, surface mounted lamp, RH version	Mirror cabinet with shelf on one side 128/80, surface mounted lamp, LH version	Mirror cabinet with shelf on one side 128/80, surface mounted lamp, RH version
Item number	SG96EH-L	SG96EH-R	SG12EH-L	SG12EH-R
Oak SG or EH *				
Surcharge for washbasin aera lighting	(-W96)	(-W96)	(-W12)	(-W12)
Surcharge makeup mirror	(-SP)			

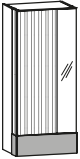
	2 adjustable glass shelves each 1 double internal socket 	2 middle sides 2 adjustable glass shelves each 1 double internal socket 	Suitable for mirror cabinets 	Suitable for mirror cabinets 
	W/D/H in cm: 128 / 16,2 / 80	W/D/H in cm: 160 / 16,2 / 80	W/D/H in cm: 28 / 11 / 7	W/D/H in cm: 28 / 11 / 7
Description	Mirror cabinet with central shelf 128/80, surface mounted lamp	mirror cabinet with central shelf 160/80, surface mounted lamp	Make-up insert 28/11 cm	Make-up tray, wood 28/11 cm
Item number	SG12MH	SG16MH	BSE28	BSS28
Oak SG or EH *				
Surcharge for washbasin aera lighting	(-W12)	(-W16)		
Surcharge makeup mirror	(-SP)			

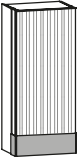
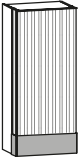
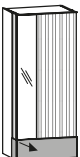
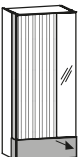
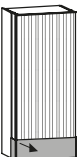
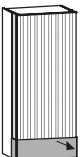
Doors protrude on hinge side when opened (5 cm clearance from wall must be allowed)	3 Glass shelves	3 Glass shelves	3 Glass shelves	3 Glass shelves
				
	WD/H in cm: 48 / 35,1 / 112	WD/H in cm: 48 / 35,1 / 112	WD/H in cm: 48 / 35,1 / 112	WD/H in cm: 48 / 35,1 / 112
	highboard, 1 relief door, mirror, door mounted on left	highboard, 1 relief door, mirror, door mounted on right	highboard, 1 relief door, door mounted on left	highboard, 1 relief door, door mounted on right
	HBG-L	HBG-R	HBR-L	HBR-R
Oak SG or EH *				
Surcharge for double drawer instead of flap			(-140)	
Doors protrude on hinge side when opened (5 cm clearance from wall must be allowed)	2 Glass shelves	2 Glass shelves	2 Glass shelves	2 Glass shelves
				
	WD/H in cm: 48 / 35,1 / 112	WD/H in cm: 48 / 35,1 / 112	WD/H in cm: 48 / 35,1 / 112	WD/H in cm: 48 / 35,1 / 112
	Highboard, 1 relief door, mirror, 1 drawer, door mounted on left	Highboard, 1 relief door, mirror, 1 drawer, door mounted on right	highboard, 1 relief door, 1 drawer, door mounted on left	highboard, 1 relief door, 1 drawer, door mounted on right
	HBGS-L	HBGS-R	HBRS-L	HBRS-R
Oak SG or EH *				
Surcharge for double internal socket with 2x USB connections for charger			(-DS)	

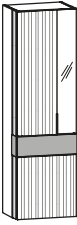
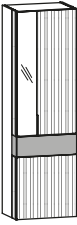
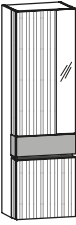
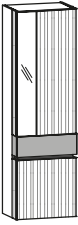
Doors protrude on hinge side when opened (5 cm clearance from wall must be allowed)	1 fixed bottom 3 Glass shelves		1 fixed bottom 3 Glass shelves		1 fixed bottom 3 Glass shelves		1 fixed bottom 3 Glass shelves	
	W/D/H in cm: 48 / 35,1 / 160		W/D/H in cm: 48 / 35,1 / 160		W/D/H in cm: 48 / 35,1 / 160		W/D/H in cm: 48 / 35,1 / 160	
	tall cabinet, 1 relief door, mirror, door mounted on left		tall cabinet, 1 relief door, mirror, door mounted on right		tall cabinet, 2 relief doors, mirror, door mounted on left		tall cabinet, 2 relief doors, mirror, door mounted on right	
	Item number HSG-L		Item number HSG-R		Item number HSGD-L		Item number HSGD-R	
	Oak SG or EH *							

Surcharge for double drawer instead of flap (-140)

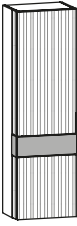
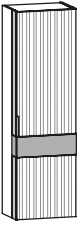
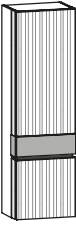
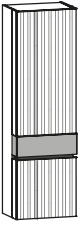

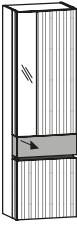
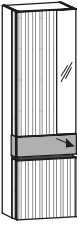
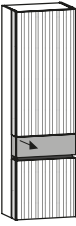
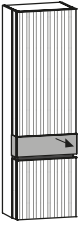

Doors protrude on hinge side when opened (5 cm clearance from wall must be allowed)	1 fixed bottom 3 Glass shelves		1 fixed bottom 3 Glass shelves		1 fixed bottom 3 Glass shelves		1 fixed bottom 3 Glass shelves	
	W/D/H in cm: 48 / 35,1 / 160		W/D/H in cm: 48 / 35,1 / 160		W/D/H in cm: 48 / 35,1 / 160		W/D/H in cm: 48 / 35,1 / 160	
	tall cabinet, 1 relief door, door mounted on left		tall cabinet, 1 relief door, door mounted on right		tall cabinet, 2 relief doors, door mounted on left		tall cabinet, 2 relief doors, door mounted on right	
	Item number HSR-L		Item number HSR-R		Item number HSRD-L		Item number HSRD-R	
	Oak SG or EH *							



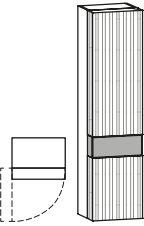
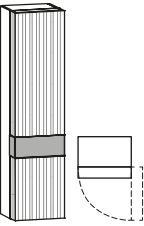

Surcharge for double drawer instead of flap (-140)



Doors protrude on hinge side when opened (5 cm clearance from wall must be allowed)	2 fixed shelves 2 Glass shelves		2 fixed shelves 2 Glass shelves		2 fixed shelves 2 Glass shelves		2 fixed shelves 2 Glass shelves	
	W/D/H in cm: 48 / 35,1 / 160		W/D/H in cm: 48 / 35,1 / 160		W/D/H in cm: 48 / 35,1 / 160		W/D/H in cm: 48 / 35,1 / 160	
	tall cabinet, 2 relief doors, mirror, 1 drawer, door mounted on left		tall cabinet, 2 relief doors, mirror, 1 drawer, door mounted on right		tall cabinet, 2 relief doors, 1 drawer, door mounted on left		tall cabinet, 2 relief doors, 1 drawer, door mounted on right	
	Item number HSGDS-L		Item number HSGDS-R		Item number HSRDS-L		Item number HSRDS-R	
	Oak SG or EH *							

Surcharge for double internal socket with 2x USB connections for charger (-DS)

Doors protrude on hinge side when opened (16 cm clearance from wall must be allowed)	1 fixed bottom 2 Glass shelves		1 fixed bottom 2 Glass shelves					
	W/D/H in cm: 39,8 / 36 / 160		W/D/H in cm: 39,8 / 36 / 160					
	tall cabinet, 1 relief door, door mounted on left		tall cabinet, 1 relief door, door mounted on right					
	Item number HSKR-L		Item number HSKR-R					
	Oak SG or EH *							

	Mobile, with 4 casters. With removable internal linen bag.	glass compartments and towel holder adjustable			
					
	W/D/H in cm: 49 / 46 / 60	W/D/H in cm: 31,2 / 33,9 / 160	W/D/H in cm: 30 / 20 / 2,6	W/D/H in cm: 0,4 / 30 / 9,15	W/D/H in cm: 20 / 13 / 24
Description	Laundry Cube 49	wall panel, 2 glass compartments, 2 towel rails	1 glass shelf for wall panel	1 towel rack for wall panel	Make-up mirror
Item number	BW49	WP31	BGF31	BMH31	SSP
Oak SG or EH *					

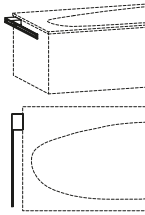
Floating wall shelves with clip-on fitting Max. total loading capacity 10 kg				
	W/D/H in cm: 64 / 14,5 / 3,9	W/D/H in cm: 96 / 14,5 / 3,9	W/D/H in cm: 128 / 14,5 / 3,9	W/D/H in cm: 160 / 14,5 / 3,9
Description	Wall shelf 64/15 cm	Wall shelf 96/15 cm	Wall shelf 128/15 cm	Wall shelf 160/15 cm
Item number	BWS64	BWS96	BWS12	BWS16
Oak SG or EH *				

Schuko (earthed) power socket in silver grey for screw-mounting to flap cover. 190 cm connection lead with Schuko (earthed) angled plug		Can be fitted on left and right		W/D/H in cm: 6 / 49 / 2,5	When cutting to size at a later date, the cut edge must be protected against the penetration of moisture!	(coreboard, veneered, edged all round) Max. length 252 cm max. width 110 cm Material thickness: 14, 20 or 23 mm
						
Description	Surface mounted plug socket w. connection cable	Hand towel holder for vanity unit cabinet	Description	Filler panel, both sides veneered		
Item number	BST1	BHH49	Item number	BLBS		
			Oak SG or EH *	(per m ²)		

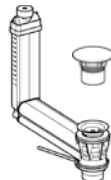
Connection 1 1/4-inch only suitable for acrylic stone and glass washbasins		Connection 1 1/4-inch only suitable for built-under basin		Surcharge Permanent waste set			Surcharge Waste and overflow set		
				Acrylic stone white	Glass white mat	Glass white	Acrylic stone white	Glass white mat	Glass white
Description									
Item number	BAPA-AW	BAPA-GM	BAPA-GW	BAUA-AW	BAUA-GM	BAUA-GW			

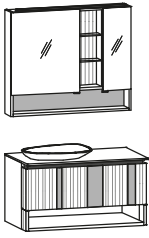
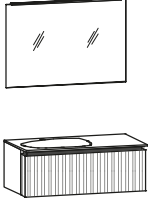
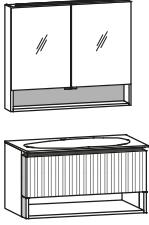
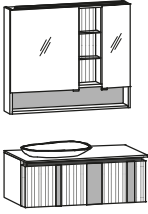
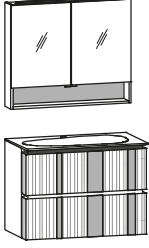
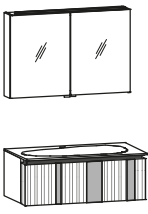
Suggestion (illustrated) consisting of: with 1 tap hole (available without tap hole on request)	1x W96EFA-L 1x BW97EAK-L 1x SG96E-L	Vanity unit 96/50, 1 drawer, open compartment, stone accent, LH version Furniture washbasin 97, countertop basin on the side, LH version mirror cabinet 96/80, one-sided shelf, built-on, stone accent, LH version	1x W96E-L 1x BW97EUK-L 1x SP96AU	Vanity unit 96/34, 1 drawer, LH version Furniture washbasin 97, undermount basin, lateral, LH version mirror 96/64, surface mounted lamp		
						
Accessories page 6		Accessories page 6				
Description	Suggestion 21			Suggestion 24		
Washbasin	Acrylic stone white			Acrylic stone white	Glass white mat	Glass white
Item number	B21-AW-L			B24-AW-L	B24-GM-L	B24-GW-L
Oak SG or EH *						
Surcharge for Permanent waste set	(-P1)			(-P1)		
Surcharge for waste and overflow system	---			(-U1)		
Surcharge for washbasin aera lighting	(-W96)			(-W96)		
Surcharge lighting with touch sensor	(-W96U)			(-W96U)		
Surcharge makeup mirror	(-SP)			---		
Suggestion (illustrated) consisting of: with 1 tap hole (available without tap hole on request)	1x W96MF 1x BW97MUK 1x SE96	Vanity unit 96/50, 1 drawer, open compartment furniture washbasin 97, undermount basin mirror cabinet with shelf 96/80, 2-door, mounted light, stone accent	1x W96EA-L 1x BW97EAK-L 1x SG96E-L	vanity unit 96/34, 1 drawer, stone accent, LH version Furniture washbasin 97, countertop basin on the side, LH version mirror cabinet 96/80, one-sided shelf, built-on, stone accent, LH version		
						
Accessories page 5		Accessories page 6				
Description	Suggestion 27			Suggestion 30		
Washbasin	Acrylic stone white	Glass white mat	Glass white	Acrylic stone white		
Item number	B27-AW	B27-GM	B27-GW	B30-AW-L		
Oak SG or EH *						
Surcharge for Permanent waste set	(-P1)			(-P1)		
Surcharge for waste and overflow system	(-U1)			---		
Surcharge for washbasin aera lighting	(-W96)			(-W96)		
Surcharge lighting with touch sensor	(-W96U)			(-W96U)		
Surcharge makeup mirror	(-SP)			(-SP)		
Suggestion (illustrated) consisting of: with 1 tap hole (available without tap hole on request)	1x W96MHA 1x BW97MUK 1x SE96	vanity unit 96/68, 2 drawers, stone accent furniture washbasin 97, undermount basin mirror cabinet with shelf 96/80, 2-door, mounted light, stone accent	1x W96MA 1x BW97MUK 1x SS96AU	vanity unit 96/34, 1 drawer, stone accent furniture washbasin 97, undermount basin mirror cabinet 96/64, 2-door, surface mounted lamp		
						
Accessories page 5		Accessories page 5				
Description	Suggestion 33			Suggestion 36		
Washbasin	Acrylic stone white	Glass white mat	Glass white	Acrylic stone white	Glass white mat	Glass white
Item number	B33-AW	B33-GM	B33-GW	B36-AW	B36-GM	B36-GW
Oak SG or EH *						
Surcharge for Permanent waste set	(-P1)			(-P1)		
Surcharge for waste and overflow system	(-U1)			(-U1)		
Surcharge for washbasin aera lighting	(-W96)			(-W96)		
Surcharge lighting with touch sensor	(-W96U)			(-W96U)		
Surcharge makeup mirror	(-SP)			(-SP)		

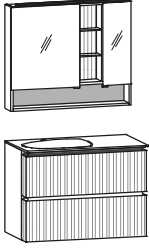
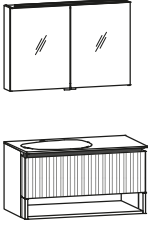
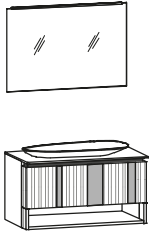
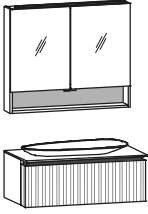
Suggestion (illustrated) consisting of: with 1 tap hole (available without tap hole on request)	1x W96EH-L 1x BW97EUK-L 1x SG96E-L	Vanity unit 96/68, 2 drawers, LH version Furniture washbasin 97, undermount basin, lateral, LH version mirror cabinet 96/80, one-sided shelf, built-on, stone accent, LH version	1x W96EF-L 1x BW97EUK-L 1x SS96AU	Vanity unit 96/50, 1 drawer, open compartment, LH version Furniture washbasin 97, undermount basin, lateral, LH version mirror cabinet 96/64, 2-door, surface mounted lamp		
						
Accessories page 6		Accessories page 6				
Description	Suggestion 39			Suggestion 42		
Washbasin	Acrylic stone white	Glass white mat	Glass white	Acrylic stone white	Glass white mat	Glass white
Item number	B39-AW-L	B39-GM-L	B39-GW-L	B42-AW-L	B42-GM-L	B42-GW-L
Oak SG or EH *						
Surcharge for Permanent waste set	(-P1)			(-P1)		
Surcharge for waste and overflow system	(-U1)			(-U1)		
Surcharge for washbasin aera lighting	(-W96)			(-W96)		
Surcharge lighting with touch sensor	(-W96U)			(-W96U)		
Surcharge makeup mirror	(-SP)			(-SP)		
Suggestion (illustrated) consisting of: with 1 tap hole (available without tap hole on request)	1x W96MFA 1x BW97MAK 1x SP96AU	Vanity unit 96/50, 1 drawer, open compartment, stone accent furniture washbasin 97, countertop basin mirror 96/64, surface mounted lamp	1x W96M 1x BW97MAK 1x SE96	Vanity unit 96/34, 1 drawer furniture washbasin 97, countertop basin mirror cabinet with shelf 96/80, 2-door, mounted light, stone accent		
						
Accessories page 5		Accessories page 5				
Description	Suggestion 45			Suggestion 48		
Washbasin	Acrylic stone white			Acrylic stone white		
Item number	B45-AW			B48-AW		
Oak SG or EH *						
Surcharge for Permanent waste set	(-P1)			(-P1)		
Surcharge for waste and overflow system	---			---		
Surcharge for washbasin aera lighting	(-W96)			(-W96)		
Surcharge lighting with touch sensor	(-W96U)			(-W96U)		
Surcharge makeup mirror	---			(-SP)		

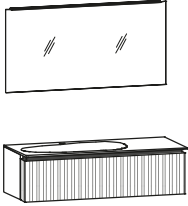
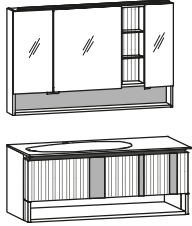
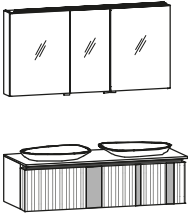
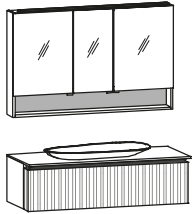
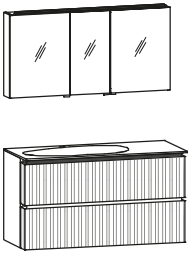
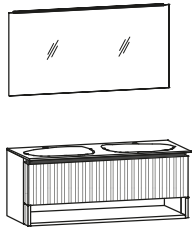
Suggestion (illustrated) consisting of:	1x W12E-L Vanity unit 128/34, 1 drawer, LH version 1x BW12EUK-L Furniture washbasin 129, undermount basin on the side, LH version 1x SP12AU Mirror 128/64, surface mounted light			1x W12EFA-L Vanity unit 128/50, 1 drawer, open compartment, stone accent, LH version 1x BW12EUK-L Furniture washbasin 129, undermount basin on the side, LH version 1x SG12E-L Mirror cabinet 128/80, shelf on one side, mounted light, stone accent, LH version		
	 <p>Accessories page 8</p>			 <p>Accessories page 8</p>		
with 1 tap hole (available without tap hole on request)						
Description	Suggestion 51			Suggestion 54		
Washbasin	Acrylic stone white	Glass white mat	Glass white	Acrylic stone white	Glass white mat	Glass white
Item number	B51-AW-L	B51-GM-L	B51-GW-L	B54-AW-L	B54-GM-L	B54-GW-L
Oak SG or EH *						
Surcharge for Permanent waste set	(-P1)			(-P1)		
Surcharge for waste and overflow system	(-U1)			(-U1)		
Surcharge for washbasin aera lighting	(-W12)			(-W12)		
Surcharge lighting with touch sensor	(-W12U)			(-W12U)		
Surcharge makeup mirror	---			(-SP)		
Suggestion (illustrated) consisting of:	1x W12DA Double washbasin cabinet 128/34, 1 drawer, stone accent 1x BW12DAK Double furniture washbasin 129, countertop basin 1x SS12AU mirror cabinet 128/64, 3-door, surface mounted lamp			1x W12M Vanity unit 128/34, 1 drawer 1x BW12MAK furniture washbasin 129, countertop basin 1x SE12 mirror cabinet with shelf 128/80, 3-door, mounted light, stone accent		
	 <p>Accessories page 11</p>			 <p>Accessories page 10</p>		
with tap hole (available without tap hole on request)						
Description	Suggestion 57			Suggestion 60		
Washbasin	Acrylic stone white			Acrylic stone white		
Item number	B57-AW			B60-AW		
Oak SG or EH *						
Surcharge for Permanent waste set	(-P2)			(-P1)		
Surcharge for waste and overflow system	---			---		
Surcharge for washbasin aera lighting	(-W12)			(-W12)		
Surcharge lighting with touch sensor	(-W12U)			(-W12U)		
Surcharge makeup mirror	(-SP)			(-SP)		
Suggestion (illustrated) consisting of:	1x W12EH-L Vanity unit 128/68, 2 drawers, LH version 1x BW12EUK-L Furniture washbasin 129, undermount basin on the side, LH version 1x SS12AU mirror cabinet 128/64, 3-door, surface mounted lamp			1x W12DF Double vanity unit 128/50, 1 drawer, open compartment 1x BW12DUK Double furniture washbasin 129, undermount basin 1x SP12AU Mirror 128/64, surface mounted light		
	 <p>Accessories page 8</p>			 <p>Accessories page 11</p>		
with tap hole (available without tap hole on request)						
Description	Suggestion 63			Suggestion 66		
Washbasin	Acrylic stone white	Glass white mat	Glass white	Acrylic stone white	Glass white mat	Glass white
Item number	B63-AW-L	B63-GM-L	B63-GW-L	B66-AW	B66-GM	B66-GW
Oak SG or EH *						
Surcharge for Permanent waste set	(-P1)			(-P2)		
Surcharge for waste and overflow system	(-U1)			(-U2)		
Surcharge for washbasin aera lighting	(-W12)			(-W12)		
Surcharge lighting with touch sensor	(-W12U)			(-W12U)		
Surcharge makeup mirror	(-SP)			---		

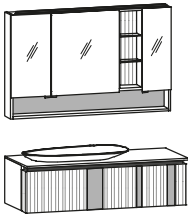
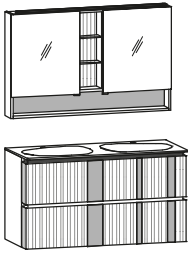
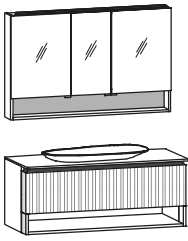
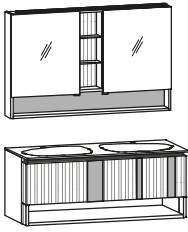
Suggestion (illustrated) consisting of:	1x W12EA-L vanity unit 128/34, 1 drawer, stone accent, LH version 1x BW12EAK-L Furniture washbasin 129, countertop basin on the side, LH version 1x SG12E-L Mirror cabinet 128/80, shelf on one side, mounted light, stone accent, LH version	1x W12DHA double vanity unit 128/68, 2 drawers, stone accent 1x BW12DUK Double furniture washbasin 129, undermount basin 1x SG12M Mirrored cabinet 128/80, center shelf, mounted light, stone accent		
	 <p>Accessories page 8</p>	 <p>Accessories page 11</p>		
with tap hole (available without tap hole on request)				
Description	Suggestion 69	Suggestion 72		
Washbasin	Acrylic stone white	Acrylic stone white	Glass white mat	Glass white
Item number	B69-AW-L	B72-AW	B72-GM	B72-GW
Oak SG or EH *				
Surcharge for Permanent waste set	(-P1)			(-P2)
Surcharge for waste and overflow system	---			(-U2)
Surcharge for washbasin aera lighting	(-W12)			(-W12)
Surcharge lighting with touch sensor	(-W12U)			(-W12U)
Surcharge makeup mirror	(-SP)			(-SP)
Suggestion (illustrated) consisting of:	1x W12MF vanity unit 128/50, 1 drawer, open compartment 1x BW12MAK furniture washbasin 129, countertop basin 1x SE12 mirror cabinet with shelf 128/80, 3-door, mounted light, stone accent	1x W12DFA double vanity unit 128/50, 1 drawer, open compartment, stone accent 1x BW12DUK Double furniture washbasin 129, undermount basin 1x SG12M Mirrored cabinet 128/80, center shelf, mounted light, stone accent		
	 <p>Accessories page 10</p>	 <p>Accessories page 11</p>		
with tap hole (available without tap hole on request)				
Description	Suggestion 75	Suggestion 78		
Washbasin	Acrylic stone white	Acrylic stone white	Glass white mat	Glass white
Item number	B75-AW	B78-AW	B78-GM	B78-GW
Oak SG or EH *				
Surcharge for Permanent waste set	(-P1)			(-P2)
Surcharge for waste and overflow system	---			(-U2)
Surcharge for washbasin aera lighting	(-W12)			(-W12)
Surcharge lighting with touch sensor	(-W12U)			(-W12U)
Surcharge makeup mirror	(-SP)			(-SP)

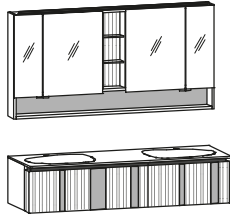
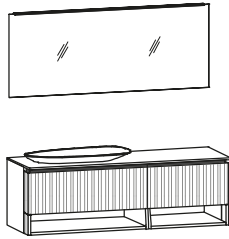
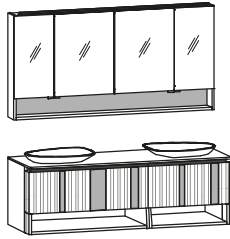
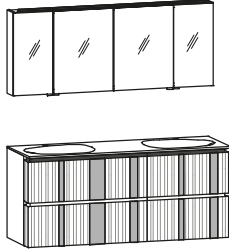
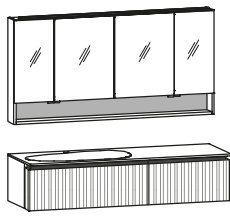
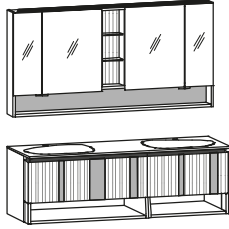
Suggestion (illustrated) consisting of:	1x W16DA 1x BW16DUK 1x SG16M Double vanity unit 160/34, 2 drawers, stone accent double furniture washbasin 161, undermount basin mirror cabinet 160/80, center shelf, built-on, stone accent			1x W16EF-L 1x BW16EAK-L 1x SP16AU vanity unit 160/50, 2 drawers, open compartment, LH version furniture washbasin 161, countertop basin on the side, LH version Mirror 160/64, surface mounted light		
						
with tap hole (available without tap hole on request)	Accessories page 14			Accessories page 12		
Description	Suggestion 81			Suggestion 84		
Washbasin	Acrylic stone white	Glass white mat	Glass white	Acrylic stone white		
Item number	B81-AW	B81-GM	B81-GW	B84-AW-L		
Oak SG or EH *						
Surcharge for Permanent waste set	(-P2)			(-P1)		
Surcharge for waste and overflow system	(-U2)			---		
Surcharge for washbasin aera lighting	(-W16)			(-W16)		
Surcharge lighting with touch sensor	(-W16U)			(-W16U)		
Surcharge makeup mirror	(-SP)			---		
Suggestion (illustrated) consisting of:	1x W16DFA 1x BW16DAK 1x SE16 double vanity unit 160/50, 2 drawers, open compartment, stone accent double furniture washbasin 161, countertop basin Mirror cabinet with shelf 160/80, 4-door, surface mounted lamp			1x W16DHA 1x BW16DUK 1x SS16AU double vanity unit 160/68, 4 drawers, stone accent double furniture washbasin 161, undermount basin mirror cabinet 160/64, 4-door, surface mounted lamp		
						
with tap hole (available without tap hole on request)	Accessories page 14			Accessories page 14		
Description	Suggestion 87			Suggestion 90		
Washbasin	Acrylic stone white			Acrylic stone white	Glass white mat	Glass white
Item number	B87-AW			B90-AW	B90-GM	B90-GW
Oak SG or EH *						
Surcharge for Permanent waste set	(-P2)			(-P2)		
Surcharge for waste and overflow system	---			(-U2)		
Surcharge for washbasin aera lighting	(-W16)			(-W16)		
Surcharge lighting with touch sensor	(-W16U)			(-W16U)		
Surcharge makeup mirror	(-SP)			(-SP)		
Suggestion (illustrated) consisting of:	1x W16E-L 1x BW16EUK-L 1x SE16 Vanity unit 160/34, 2 drawers, LH version Furniture washbasin 1610, undermount basin on the side, LH version Mirror cabinet with shelf 160/80, 4-door, surface mounted lamp			1x W16DFA 1x BW16DUK 1x SG16M double vanity unit 160/50, 2 drawers, open compartment, stone accent double furniture washbasin 161, undermount basin mirror cabinet 160/80, center shelf, built-on, stone accent		
						
with tap hole (available without tap hole on request)	Accessories page 12			Accessories page 14		
Description	Suggestion 93			Suggestion 96		
Washbasin	Acrylic stone white	Glass white mat	Glass white	Acrylic stone white	Glass white mat	Glass white
Item number	B93-AW-L	B93-GM-L	B93-GW-L	B96-AW	B96-GM	B96-GW
Oak SG or EH *						
Surcharge for Permanent waste set	(-P1)			(-P2)		
Surcharge for waste and overflow system	(-U1)			(-U2)		
Surcharge for washbasin aera lighting	(-W16)			(-W16)		
Surcharge lighting with touch sensor	(-W16U)			(-W16U)		
Surcharge makeup mirror	(-SP)			(-SP)		



GENERAL CONDITIONS OF SALE

1. General

1.1. The following terms of sale and delivery, hereinafter referred to as "GTC", apply to all business relationships (such as purchase contracts, work contracts, planning orders etc.) between VOGLAUER Gschwandtner & Zwilling GmbH, Voglauer hotel concept business division, hereinafter referred to as "VOGLAUER", and customers. By placing an order or entering into a contract with VOGLAUER, the customer accepts these as binding. Deviations, contradictions or supplementary general terms and conditions will not be binding on this contract, even when they are known about at the time, unless they are expressly agreed in writing. If conditions which deviate from these GTC are agreed in writing, these additional considerations shall apply.

1.2. VOGLAUER generally only enters into contracts with companies, which is why the GTC were designed for legal transactions between companies. If, in exceptional cases, they are also used as a basis for legal transactions with consumers, they shall only apply insofar as they do not violate mandatory provisions of consumer protection law.

2. Offers, prices

2.1. All prices quoted by VOGLAUER in offers and price lists are subject to change and are net prices, unless it is expressly stated that statutory value added tax is included. Value added tax shall be charged separately in accordance with the statutory provisions applicable on the day of delivery or performance. VOGLAUER reserves the right to make technical and other reasonable changes. If a customer's order does not contain any price information, VOGLAUER's price lists applicable on the day the order is received shall apply to this order.

2.2. Export deliveries are generally charged in euros and must also be paid in euros. If another currency is expressly agreed, VOGLAUER will invoice on the basis of the exchange rate to the Euro on the day that the order is confirmed. The rates calculated by the Austrian banks are applied for this purpose.

2.3. Export deliveries are generally charged in Euro and are also payable in Euro. If another currency has been explicitly agreed, VOGLAUER will invoice on the basis of the Euro exchange rate of the day on which the order has been confirmed. The price calculation of the Austrian National Bank (ONB) (published on: <https://www.onb.at/zinssatzwechselkurse/>) is the only relevant calculation.

3. Order acceptance, order basis

3.1. If an order is placed with VOGLAUER, a contract is only entered into when VOGLAUER confirms the order in writing or delivers the goods or sends the invoice. The customer is obliged to provide all required documents completely and correctly when placing the order. Any additional costs due to discrepancies between the actual circumstances and the documents or plans provided by the customer as well as additional costs due to late delivery of the documents are to be borne by the customer. Changes may only be made to the order after acceptance by mutual agreement and in writing.

3.2. If at the time of the order being placed, the ordered goods are not fully specified in detail (especially their technical design), a preliminary order confirmation will be issued. The customer is obliged to provide sufficient details of the order in a timely manner (notification of actual measurements) to ensure that agreed delivery times can be met. Upon the provision of details a final order acknowledgement is issued by which the subject matter of the contract becomes binding, unless the customer expressly immediately dissent in writing. Should this happen, the delivery contract remains valid, in accordance with the preliminary order confirmation. If an order is changed after a preliminary order confirmation, prices will be adjusted in accordance with a preceding cost estimate if need be.

4. Shipping, delivery

4.1. Unless otherwise agreed, the delivery of goods is free of charge. The goods are unloaded from the arriving means of transport and made available to the contracting party at the place designated for unloading, i.e. either in the loading dock or consignment area. Transport insurance shall only be arranged at the customer's explicit request. Any resulting costs shall solely be borne by the customer. If not specified otherwise in writing, the risk of price is passed to the customer upon the dispatch of the goods, in the event of a delay in acceptance caused by the customer, after VOGLAUER's notification of readiness of dispatch.

4.2. The selection of the place of delivery and of the route and means of transport is made by VOGLAUER, in the absence of any written agreement to the contrary, to the best of their judgment, and without liability for the cheapest and fastest transport. Specified delivery times are not binding, unless otherwise expressly agreed in writing.

4.3. The agreed delivery period will generally commence on the day of the order confirmation. If at this moment in time (starting point of the period) the documentation required for production, such as in particular actual measurements, has not been made available to VOGLAUER, the course of the delivery period shall commence on the day where the final documentation required for production has been received by VOGLAUER. The customer is obliged to transmit such documentation promptly. Delivery dates (delivery deadlines) shall be extended by installation delays not caused by VOGLAUER. Should the customer have to make an advance payment, then the delivery period shall not start before the day before the advance payment has been received.

4.4. Should the customer be in delay of acceptance of the delivery item – even if not at fault himself – VOGLAUER has the right to raise the usual storage charge; in addition, VOGLAUER is entitled to withdraw from the delivery contract and the customer is obliged to pay the difference between the agreed price and the expected revenue from the realisation of the deliverable goods. In cases where installation is part of the agreement, the customer is obliged to accept the contractual items after completion of the installation after a site inspection of the contractual goods. The provisions on creditor default apply where acceptance is refused.

4.5. Should VOGLAUER fail to meet delivery dates by more than 3 weeks, customers have the right to withdraw from the contract after a reasonable period of grace has been set. Should the delivery period be exceeded due to operational reasons which are beyond the control of VOGLAUER even when exercising the diligence of a prudent business management (in particular strikes, operational breakdowns, shortage of raw materials, but also cases of force majeure such as epidemics and epidemics leading to plant closures ("lockdown" etc.), the customer is only entitled to withdraw from the contract when the delivery period of 2 months is exceeded and an appropriate grace period is granted.

4.6. To ensure an efficient and reasonable delivery to the contracting party by VOGLAUER, the parties shall agree that for delivery and unloading the standards for unloading, as issued by the Future Institute Furniture Logistics (ZIMLOG) in their current version, shall apply. These are available for downloading online under www.dcc-moebel.org/zimlog.html or can be sent in text form to the contracting party on request.

4.7. VOGLAUER is entitled to deliver in excess or below the contracted quantity. In the case of a delivery carried out to the extent as described above, the contracting party is not entitled to refuse acceptance.

4.8. If in individual cases, a contractual penalty has been agreed between the supplier and the contracting party, this can only be enforced if upon accepting the goods the contracting party has expressed their reservation in writing.

4.9. A contractual penalty provision must be sent directly to VOGLAUER. VOGLAUER's employees, drivers or any other third parties are not entitled to accept any contractual penalty provision.

5. Withdrawal from contract

5.1. If the customer does not fulfil their contractual obligations or does not meet them in full, VOGLAUER is entitled to withdraw from the contract. The right to withdraw from the contract can also be exercised with regard to a part of the delivery item. In such a case VOGLAUER is obliged to deliver the part of the delivery item not affected by the withdrawal and the customer is obliged to pay for this part.

5.2. If VOGLAUER exercises its right of withdrawal for reasons for which the customer is responsible, even if the customer is not at fault, or if the customer withdraws from the contract without being entitled to do so, the customer must pay for the advance services corresponding to the proportionate order value which have already been rendered within the scope of contract performance (e.g. planning services, procurement of materials, special services, work expenses and the like). VOGLAUER is entitled to claim a lump sum for preliminary work calculated at 25% of the order value without having to provide specific proof of individual services rendered. The costs of custom-made products already produced are to be fully

reimbursed less assembly and delivery costs.

6. Assembly

6.1. The customer must ensure that installation can be carried out without delay; in particular that the fitters are not impeded by other trespassers. Furthermore, the rooms to be furnished in the assembly area must be kept ready, heated if necessary, cleaned, sufficiently illuminated and provided with an electrical connection. The costs for electricity and water consumption shall be borne by the customer. Carpets must be made non-slip by the customer and adequately covered to protect against dirt and damage.

6.2. If, in the course of installation, mounting is required on fixtures belonging to the customer or third parties (e.g. fastening to the masonry by drilling or mortising), the customer is obliged to draw VOGLAUER's attention to potential hazards before commencing work, in particular the exact course of electricity, gas, water and other pipeline systems must be pointed out.

6.3. VOGLAUER is not obliged to examine the properties of the walls or objects to which fixings are to be made during installation. However, the customer is obliged to inform VOGLAUER about properties of the walls or objects which could compromise a straightforward and problem-free installation. Any additional costs arising from unexpected properties of the walls or objects shall be borne by the customer.

6.4. Additional costs for overtime and installation delays caused by the customer as well as work not included in the order confirmation or work resulting from defective stock will be charged separately. Fine cleaning of the premises after assembly is to be carried out by the customer at their own expense. Unless otherwise agreed in the contract, the installation services offered by VOGLAUER do not include the installation and connection of any types of electrical appliances or lighting fixtures. Unless otherwise agreed, this work shall be commissioned separately by the customer at their own expense to be carried out by an appropriately authorised contractor. Packaging material must be disposed of by the customer at their own expense.

6.5. VOGLAUER is not obliged to examine the properties of walls or objects to which fixings are to be made during installation. However, the customer is obliged to inform VOGLAUER about properties of the walls or objects which could compromise a straightforward and trouble-free installation. Any additional costs arising from unexpected properties of walls or objects shall be borne by the customer.

6.6. Additional costs for overtime and installation delays caused by the customer as well as work not included in the order confirmation or work resulting from defective stock will be charged separately. This would also apply if VOGLAUER had offered fitting as a lump sum or for free as discount.

6.7. The fine cleaning of the premises after assembly is to be carried out by the customer at their own expense. Unless otherwise agreed in the contract, the installation services offered by VOGLAUER do not include the installation and connection of any type of electrical appliances or lighting fixtures. Unless otherwise agreed, this work shall be commissioned separately by the customer at their own expense to be carried out by an appropriately authorised contractor. Packaging material must be disposed of by the customer at their own expense.

7. Complaints

The customer is required to examine the goods delivered for any defects without undue delay, i.e. within eight calendar days at the latest. Incomplete or incorrect deliveries as well as immediately apparent defects must be reported to VOGLAUER in writing immediately after receipt of goods; defects or errors which are not immediately apparent must be notified as soon as they are discovered. The notification must clearly indicate the nature and extent of the alleged defect. If defects and errors are not notified promptly, the delivery shall be deemed to have been accepted and correct and no warranty claims may be made.

The customer fulfils his obligation to check and give notice of defects by checking the goods for visible quantitative or qualitative deviations using appropriate methods (please see following "Appropriate Testing Methods"). Appropriate testing methods are the following, although this is not an exhaustive list: (i) the checking of the delivered quantity of goods, (ii) the visual inspection of the packaging and (iii) the inspection of visible damages caused by transport or other matters. Obvious defects shall be notified by the contracting party within a period of two working days. The timely dispatch of the notice of defects shall suffice to comply with this deadline. Each notice of defects shall only be effective when provided in writing.

8. Warranty

VOGLAUER guarantees the delivered goods for a period of one year from the date of delivery. The warranty period for electrical appliances and lighting supplied by VOGLAUER is six months.

Warranty claims shall be subject to the customer complying with their duties of inspection and notification of defects. Should a customer fail in his duty to inspect and/or fail to meet the notification deadline, VOGLAUER's liability shall be excluded for defects not notified as above.

In cases of justified and timely notification of defects, VOGLAUER will, reasonably taking into account customer's interests, provide warranty by improvement, price reduction or replacement (exchange) or take back the goods refunding the purchase price. VOGLAUER reserves the right to choose the respective warranty remedy. If VOGLAUER does not fulfil their warranty obligations within a reasonable period of time, the customer is entitled to a reasonable price reduction or to withdraw from the contract. Activities undertaken by VOGLAUER resulting from unjustified notifications of defects shall be considered as a contractual service for which the customer has to pay.

In particular, the warranty does not apply;

- in the case of goods provided by the customer;
- in the case of damages resulting from structural defects (e.g. masonry, building moisture, building defects (e.g. defective masonry, building moisture, building defects, etc.);
- in the case of compatibility of the materials used by VOGLAUER with other parts and properties of the room to be furnished, e.g. externally provided furnishings, light colours, heating and the like;
- in the case of deformation and cracking of solid wood used;
- to the function of the delivered item and the suitability of the material used if the construction was designed by the customer or their authorised representative (e.g. architect);
- in the case of slight variations in the colours and surface or veneer structure of individual items delivered;
- the facts included in the VOGLAUER Furniture Quality Pass or the VOGLAUER manufacturer warranty declaration.

9. Disclaimer

9.1. VOGLAUER is only liable for damages outside the scope of application of the Product Liability Act if VOGLAUER is guilty of intent or gross negligence. Liability for slight negligence is excluded as well as compensation for consequential damage and financial loss, loss of profit, loss of interest and damage from third-party claims against the customer.

9.2. Within the scope of application of the Product Liability Act, VOGLAUER is liable for personal injury as well as for material damage suffered by a consumer. VOGLAUER is not liable for material damage suffered by a person in business. Furthermore, § 924 sentence 2 of the Austrian Civil Code (ABGB) and the recourse of the customer according to § 933b of the Austrian Civil Code (ABGB) is excluded. Claims for damages become statute-barred three years after delivery.

9.3. Furthermore, the contracting parties mutually waive all claims for damages insofar as these are covered by an insurance policy of the injured party. This waiver shall not apply to damages caused intentionally or through gross negligence or to the extent that the insurer would not be liable as a result of such waiver.

9.4. Locking devices and safes supplied by VOGLAUER do not constitute burglary and theft protection devices, so claims for damages in this respect are excluded. Any burglary and theft protection must therefore always be provided by the customer themselves at their own risk and expense and VOGLAUER accepts no liability for the contents locked in such devices.

10. Payment

10.1. Invoices for deliveries of goods shall be paid in accordance with the respective agreements made. Unless otherwise agreed, the customer shall pay one third

of the amount stated in the order confirmation as a down-payment promptly after placing the order, one third 2 weeks before delivery readiness and the remaining amount from the supply contract immediately after invoicing, in all cases without deduction. Unless different payment terms have been agreed in writing between the contracting parties, payments of the invoice amounts are due without deduction immediately upon receipt of the invoice. Bills of exchange or cheques shall only be accepted by specific written agreement as a means of payment. Discount and bill charges shall be borne by the customer and are due immediately. The customer acknowledges that VOGLAUER's sales representatives are not entitled to collect payments.

10.2. In the event of default in payment, it is agreed that default interest in the amount of 9.2% above the base interest rate shall be due. The customer may not offset any amounts due, unless with claims acknowledged by VOGLAUER in writing or legally established.

10.3. Should the customer no longer be able to engage in proper business operations, should enforcement proceedings be instigated, should a cheque or bill of exchange be protested, should payments be delayed or suspended, should the customer apply for judicial or extrajudicial rehabilitation proceedings or should insolvency proceedings be instituted, opened or an application for insolvency be rejected due to insufficient assets to recover costs, VOGLAUER is entitled to declare all claims arising from the business relationship immediately due and payable, even should bills of exchange or cheques be accepted or payment by instalments be granted. The same applies if the customer is in arrears with their payments or other circumstances become known which have an adverse effect on their creditworthiness.

10.4. The customer is not entitled to withhold payments due to alleged defects unless the defects and the amount of the amounts to be withheld have been acknowledged by VOGLAUER in writing or determined by court. The customer may not assign their claims against VOGLAUER to third parties and rights and obligations arising from contracts entered into may not be similarly assigned without prior written consent from VOGLAUER.

10.5. VOGLAUER is entitled to assign claims against the contracting party arising from deliveries or services to third parties (e.g. a bank or a factoring party) to the full extent permitted by applicable law. The contractual partner shall allow data to be forwarded to third parties for the purpose of the collection of the claims.

11. Retention of title

11.1. The delivered goods remain VOGLAUER's property until the customer has fully met their obligations, in particular payment of the purchase price including incidental costs and interest, fees, expenses, etc.

11.2. Deliveries performed for a specific construction project which are included in the same order form a single order, even when ordered, delivered and invoiced (partial invoice) in separate stages. In this case, the retention of title to all goods delivered for the respective construction project only expires when all claims from the uniform order are settled.

11.3. The customer may only resell goods delivered which are subject to retention of title if they are dedicated as commercial goods or if the retention of title has expired through payment or VOGLAUER expressly agrees. If the goods are resold, the customer assigns proceeds from the sale of the reserved goods to VOGLAUER. The customer is obliged to indicate the assignment by suitable entries in their accounting records and, at VOGLAUER's request, to disclose the names of the corresponding debtors as well as to specify the ceded claims in detail. Subject to this, VOGLAUER accepts the assignment. Any fees and/or taxes in connection with the assignment shall be borne by the customer and they shall indemnify and hold VOGLAUER harmless in this respect. VOGLAUER is entitled at any time to disclose the assignment and to collect the assigned claims itself.

11.4. The customer is obliged to keep the reserved goods insured to an adequate extent at all times against the usual risks such as natural hazards and to provide evidence of this to VOGLAUER upon request. The customer hereby assigns proceeds from possible insurance claims to VOGLAUER. Furthermore, the customer is obliged to store the goods in accordance with the instructions of VOGLAUER using state-of-the-art technology. Customers must handle the goods with due care and attention until the title is transferred to them.

11.5. VOGLAUER must be notified immediately of access by third parties to VOGLAUER's reserved property (seizure or description by way of pledge, other court and/or official orders). The customer must provide whatever support VOGLAUER may reasonably require in protecting VOGLAUER's rights in respect of the reserved property and to bear the associated costs, insofar as they are responsible for endangering VOGLAUER's reserved property.

11.6. In the event that the reserved goods are combined or mixed with other items, VOGLAUER shall be entitled to co-ownership of the new item in the ratio of the value of the reserved goods to the value of the other item at the time of combination or mixing. If the new item thus created is resold, the customer assigns the exact pro-rata purchase price from the resale to VOGLAUER in the sense of the above-mentioned stipulation.

12. Intellectual property

12.1. Trademarks, representations, as well as the associated drawings, plans and descriptions are VOGLAUER's intellectual property and may neither be reproduced nor made accessible to third parties without VOGLAUER's written consent.

13. Advertisement

13.1. It is agreed that objects furnished by VOGLAUER may be used by VOGLAUER for advertising purposes (reference lists, brochures, press releases, etc.) stating the name of the customer as well as using pictures of the furnished object. In this context, the customer grants VOGLAUER the right to take photographs of furnished objects.

14. Force majeure

14.1. Events of force majeure which affect VOGLAUER or one of its suppliers entitle VOGLAUER to suspend deliveries for the duration of the hindrance and a further reasonable start-up time without falling into arrears or withdrawing from the contract in whole or in part according to their effects.

Events of force majeure include, but are not limited to: all impacts of natural disasters, such as earthquakes, lightning, frost, storm, floods; in addition war, epidemics and epidemics, laws, official interventions (e.g. laws and regulations issued to prevent the spread of COVID-19 and the resulting restrictions "lockdown"), confiscation, transport disruptions, export, import and transit bans, international payment restrictions, loss of raw materials and energy; further, interruptions such as explosion, fire, strikes, sabotage; and all other events that could only be prevented at disproportionate cost and by economically unreasonable means.

15. Consent under data protection law

15.1. The customer expressly agrees that VOGLAUER may collect, process and use personal data provided by the customer, or which may be provided in the future, for marketing purposes e.g. by creating a customer file. This consent includes in particular the transmission of information for the purpose of advertising by fax, letter, email or any other method of transmission. This consent may be revoked by the customer at any time with future effect.

16. Final provisions

16.1. Austrian law shall apply with the exception of the conflict of legal provisions and the UN Convention on Contracts for the International Sale of Goods. The place of jurisdiction for all disputes arising directly or indirectly from the contract shall be the competent court in the provincial capital of Salzburg. The place of performance for delivery and payment is VOGLAUER's registered office.

16.2. Should any of these terms and conditions be wholly or partially invalid, the validity of the remaining provisions shall not be affected. The wholly or partially invalid provision is to be replaced by whatever provision comes closest to the intended purpose of the invalid provision.

16.3. All amendments and supplements to contracts between VOGLAUER and the customer must be made in writing and this also applies to departures from the written requirement. All declarations on the part of VOGLAUER are only legally effective if they are made in writing and by employees of the VOGLAUER principal office in Abtenau, Austria.

Version released on 2 October 2020.





LIVING / DINNING



Valpin



Vmontanara



Vcuben living



Vrock living



SLEEPING



Valpin sleeping



Vmontanara sleeping



Vvaganto



HALL



Valpin



Vmontanara



Vrock coming



BATH



Valpin bad



Vmontanara bad



Vquell



Vlineos

CERTIFICATIONS & AWARDS



GERMAN DESIGN AWARD



VOGLAUER



www.voglauer.com